

青岛星航维度国际贸易有限公司
Qingdao StellarVerse International Co.,Ltd

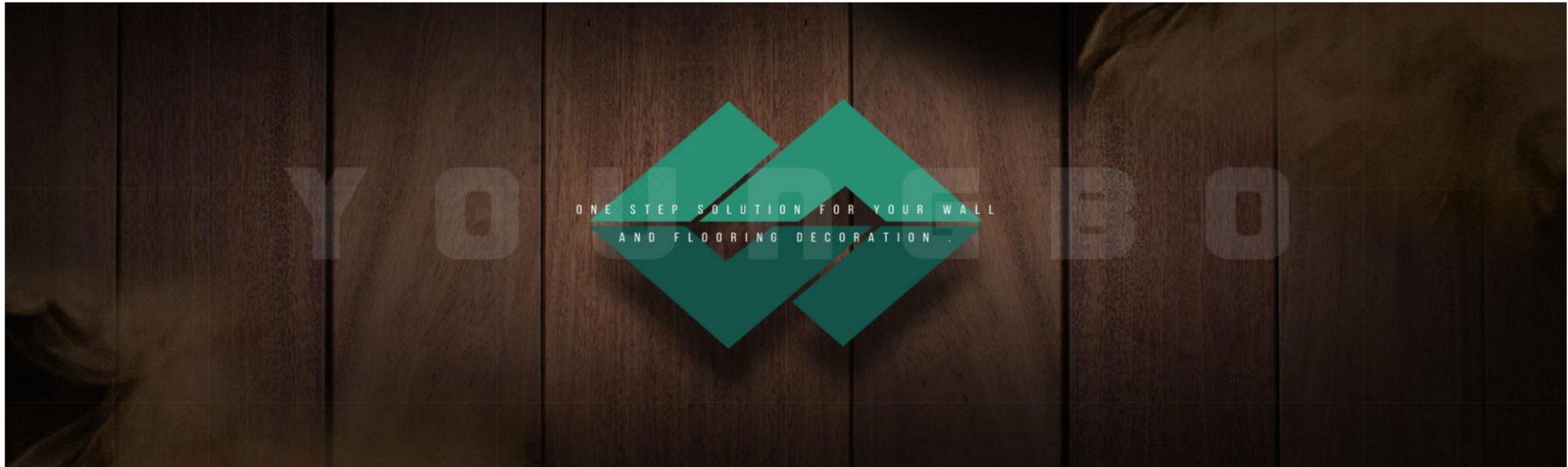

PVC石塑地板

产品概述

PVC自粘地板是以聚氯乙烯及其共聚树脂为主要原料，通过添加填料、增塑剂、稳定剂、着色剂等辅料，经搅混合搅拌挤出复合工艺生产而成。主要应用于室内家居地面装饰，因其安装简便、性能优异、花色多样美观、价格低廉等特点受到市场的广泛喜好，近几年产品体量在全球市场不断增加。

1 优势分析

安装简便：地板背面覆盖有压敏性热熔胶，用户只需撕开背面的保护层，就可以直接粘贴在平整的地面上，不需要额外的工具或胶水。

性能优异：这类地板表面强亮、坚韧，具有良好的防水、防滑性能，适用于家庭、学校、医院等多种场合。

环保健康：以环保材料制造，不含有害物质，使用过程中不释放甲醛等有害气体，对身体健康无害。

2 市场发展

市场需求：根据国家发展规划，建筑业将成为国民经济的支柱产业之一，PVC自粘地板作为其中的一部分，市场需求量大，发展前景广阔。

行业认可度：随着体育赛事和建筑工程对PVC塑胶地板的认可，PVC自粘地板的行业认可度也逐渐提高，未来发展前景乐观。

3 选择建议

考虑环境因素：选择PVC自粘地板时，需要考虑使用环境的湿度、温度等因素，以确保地板的性能和使用寿命。

考虑施工质量：施工质量直接影响到地板的使用效果和寿命，建议选择有经验的施工队伍进行安装。

生产流程(各环节巡检、抽检)

拌料 → 混料 → 挤出 → 复合 → 裁片 → 模切 → 涂胶 → 装箱 → 打托



产品结构：6层复合结构

- 升级PVC耐磨层
- 高清打印彩膜层
- 乙烯基石塑基层
- 升级底部增韧层
- 升级背面强胶层
- 易撕离型纸层

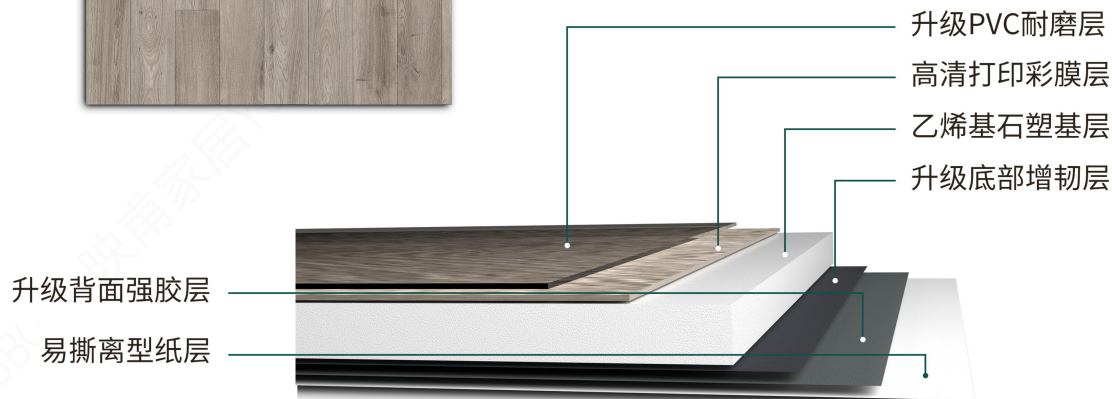

PVC石塑地板

地板表面工艺

- 1, 精选PVC耐磨层, 哑光面, 亮光面两种选择;;
- 2, 表层可进一步做UV耐磨抗老化升级处理

升级背面强胶层

环保热熔压敏胶, 无味, 初粘持粘均很好。

升级底部增韧层

底部复合增韧层, 增强产品韧性, 长期保护胶性粘力, 同时保证反复撕贴不伤地面。



PVC石塑地板

常规尺寸(regular size)	英尺 (in)	厚度 (thickness)
914.4mm*152.4mm	36*6	1.2mm
457.2MM*457.2MM	18*18	1.5mm
304.8MM*304.8MM	12*12	1.8mm
304.8MM*609.6MM	12*24	2.0mm
304.8MM*1219.2MM	12*48	2.5mm
228.6MM*1219.2MM	9*48	3.0mm

备注:

1: 常规尺寸1.5mm/1.8mm常规颜色 300平方起订, 定制颜色500平方起订。 非常规尺寸咨询客服

2: 1.2mm/2.0mm/2.5mm/3.0mm起订量2000平方起订, 常规色/定制色不限

Remarks:

1: The standard size is 1.5mm/1.8mm, with a minimum order size of 300 square meters for regular colors and 500 square meters for custom colors. Consultation with customer service on unconventional sizes

2: 1.2mm/2.0mm/2.5mm/3.0mm minimum order quantity of 2000 square meters, with no limit on regular/custom colors

PVC石塑地板

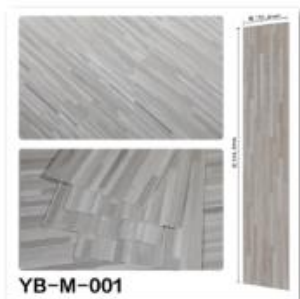

SPC石塑地板

产品概述

SPC石塑地板是一种高性能的地板产品，具备防水、防潮、防虫、防火、安装简单等多种优势，并且图案花色选择多样，非常适合家装和公共场所使用。SPC地板以其优异的环保性、耐用性和装饰性而受到广泛欢迎。

1 材料构成

SPC石塑地板是以天然石粉（碳酸钙）和聚氯乙烯（PVC）为主要原料，通过高温挤压工艺制成的地板。其结构通常包括UV防滑耐磨层、彩膜纹理印刷层、高密度基材层等多层结构，增强了地板的稳定性和耐磨性。

2 产品优点

环保性：SPC石塑地板在生产过程中无需使用胶水，无甲醛、无放射性元素，是绿色环保的新型地面材料。

耐用性：具有优异的防水、防潮、防霉变、防虫蛀、耐酸碱腐蚀等特性，适用于各种复杂环境。

装饰性：表面可模拟各种材质的纹理，如石材、木材等，色彩丰富，图案逼真美观，能满足不同装饰风格的定制需求。

3 应用范围

SPC石塑地板适用于多种场合，如家庭、学校、医院、办公楼以及商场等。其出色的稳定性和耐久性使其成为公共场所和家庭地面装修的理想选择。

4 市场前景

随着人们环保意识的增强和对健康生活的追求，SPC石塑地板因其环保和耐用的特性，市场需求持续增长。同时，技术创新和设计多样化也将推动产品的市场拓展。

5 安装维护

安装简便：SPC石塑地板采用卡扣式安装，无需使用胶水或钉子，安装快捷方便。

维护简单：只需定期使用中性清洁剂和水清洁，避免使用强酸或强碱清洁剂。

生产流程（各环节巡检、抽检）

拌料 → 混料 → 挤出 → 复合 → 裁片 → UV → 切割 → 开槽 → 装箱 → 打托

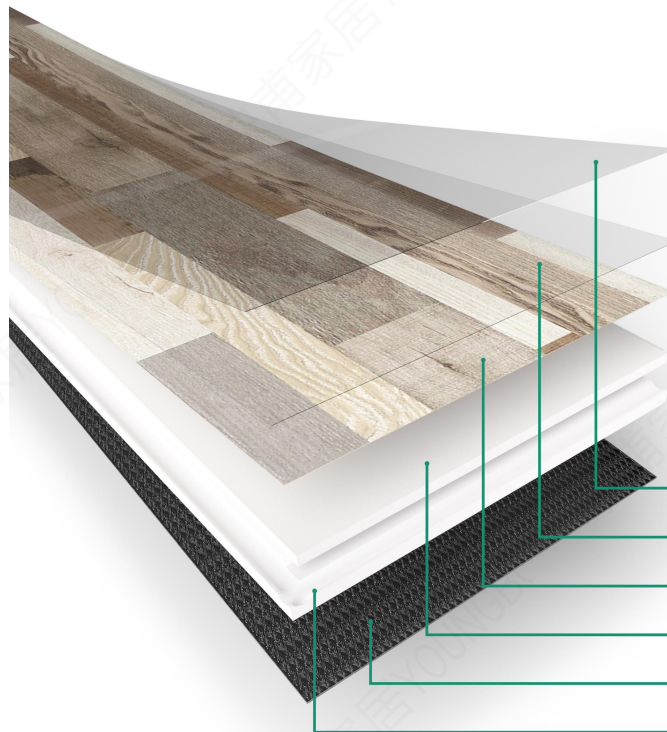

产品结构：5层复合结构

- 表面UV涂层
- 升级耐磨层
- 高清彩膜层
- 白底料石塑层
- 聚乙烯静电层
- 尤尼林卡扣

- 表面UV涂层
- 升级耐磨层
- 高清彩膜层
- 白底料石塑层
- 聚乙烯静电层
- 尤尼林卡扣

SPC石塑地板



更耐用

SPC石塑锁扣地板由石粉和环保PVC材料热压而成，比实木地板更耐磨、耐压，使用寿命更长。

更稳定

SPC石塑锁扣地板采用锁扣设计，安装时无需使用胶水，避免了因温度变化导致的地板变形、起拱等问题，更加稳定可靠。

更环保

SPC石塑锁扣地板在生产过程中不使用任何甲醛等有害物质，对环境和人体健康无害，符合现代人绿色环保的生活理念。

SPC石塑地板

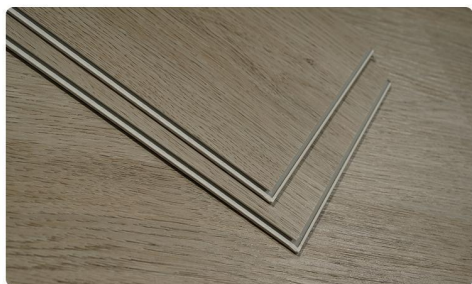
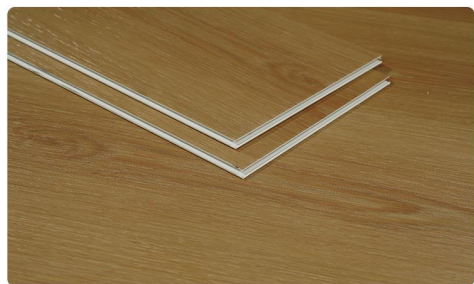

UV石塑墙板

产品概述

石塑UV墙板是一种结合了石塑材质和UV处理技术的新型墙面装饰材料，具有耐磨、防潮湿、色彩鲜艳等多种优点。

生产流程（各环节巡检、抽检）

拌料 → 混料 → 挤出 → 复合 → 裁切 → 打托

产品结构：4层复合结构

- 透明保护膜
- 高光UV层
- 高清彩膜层
- 白料石塑层

- 透明保护膜
- 高光UV层
- 高清彩膜层
- 白料石塑层

1 材料构成

石塑墙板是由天然大理石粉和高分子PVC材料复合而成，这种材料结构坚实，具有高密度和高纤维网状结构。UV处理是在板材表面涂覆一层紫外光固化漆，这层漆在经过UV光照射后迅速固化，形成坚硬的保护膜。

2 产品优点

石塑UV墙板的生产主要使用天然石粉，不含放射性元素，通过ISO9000国际质量体系认证和ISO14001国际绿色环保认证。该材料的耐磨性好，并且它的防水性能优越，适用于多种湿润环境。石塑UV墙板色彩丰富自然，能还原名石本色，表面晶莹剔透，视觉效果堪比天然名石。

3 应用范围

因为其耐磨性和防水性能，广泛应用于家庭、酒店、KTV等场所的室内墙面装饰。特别适用于高人流量的公共场合，如商场、学校、医院等，易于清洁和保养。

4 市场前景

作为一种新兴的装饰材料，石塑UV墙板凭借其环保、耐用等特性，正逐渐被市场认可和推广。随着人们对于居住和工作环境美观性与实用性的双重需求增加，石塑UV墙板的市场需求将持续增长。

5 安装维护

安装方便，可直接粘贴于平整的基地上，无需复杂的机械固定过程。维护简便，定期用干净的湿布擦拭即可，避免使用坚硬的清洁工具以免划痕。

UV石塑墙板

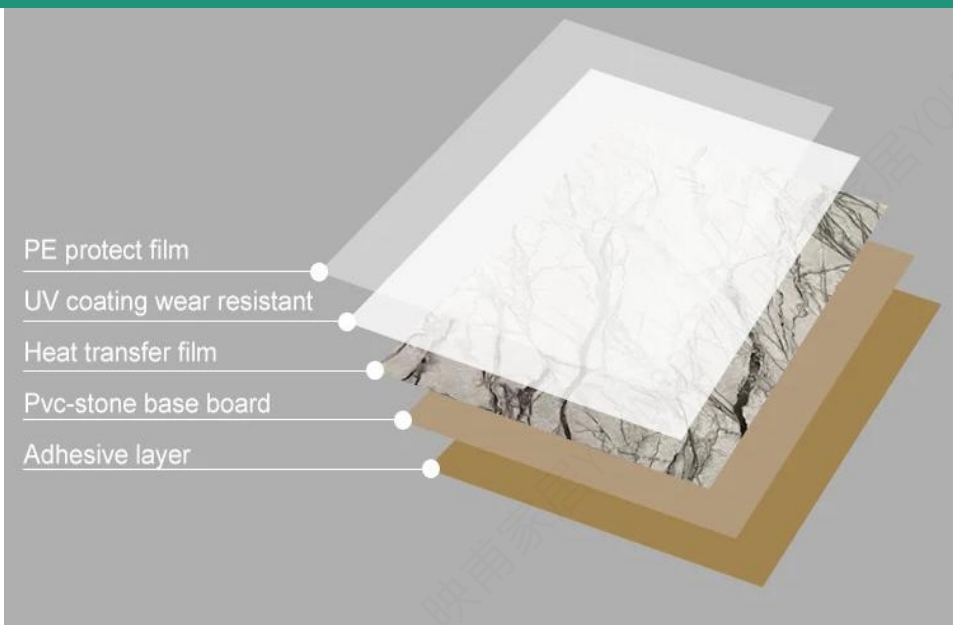

Specification 尺寸规格

厚度：2-5mm
Thickness: 2-5mm
宽度：1220mm
Width: 1220mm
长度：2440mm;2800mm;3000mm;定制
Length: 2440mm;2800mm;3000mm;定制
表面：见膜皮表（可定制）
Surface: Customized (film catalogue)
特点：防水防火，防虫，易清理，易于安装，现代化设计，环保
Features: Water Proof, Fire Proof, Anti Insect, Easy Clean, Easy Installation, Modern Fashion Design, Environmental .

Surface coating 表面包覆



卷曲/Arbitrary curl



打印画/Print painting



高光，真实/High Gloss and real

UV石塑墙板

陕南家居

陕南家居YOU

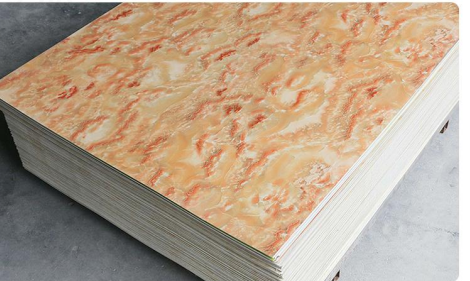
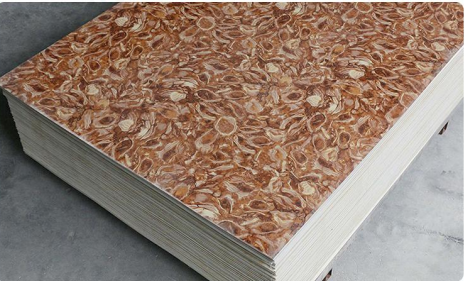
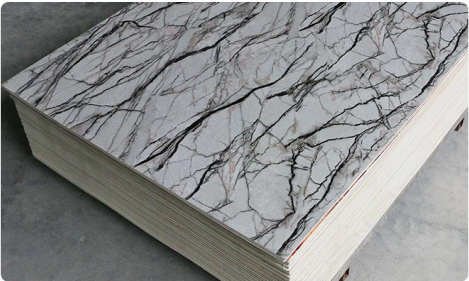
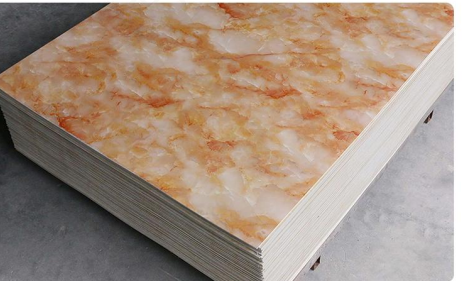
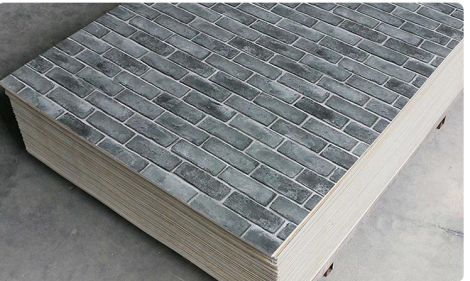
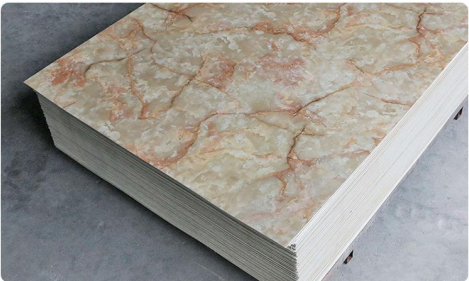
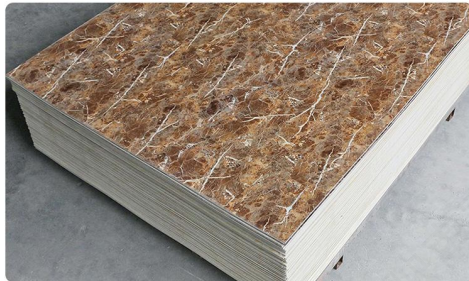
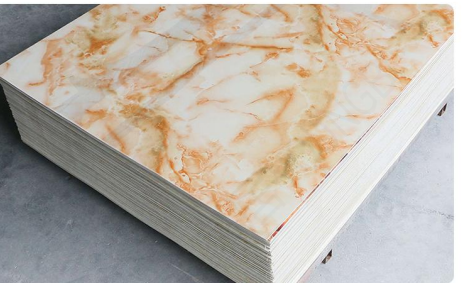
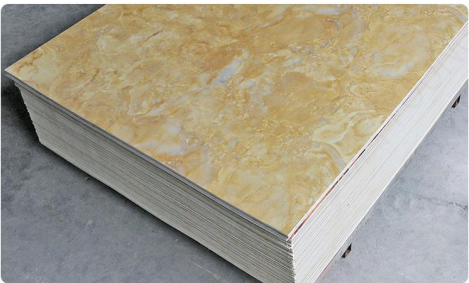

SPE装饰墙贴

产品概述

SPE装饰墙贴是一种采用SPE材料制作的用于墙面装饰的贴膜，它结合了硅胶的高性能和聚乙烯的易加工特点，为室内外墙面提供了美观与保护的双重功能。

生产流程（各环节巡检、抽检）

基材发泡 → 贴合 → 涂胶 → 模切 → 装箱

产品结构：6层复合结构

- 镜面高光PET表层
- 高清彩膜层
- 聚乙烯泡棉基材
- 环保热熔胶
- 防潮增韧铝膜底
- 离型层

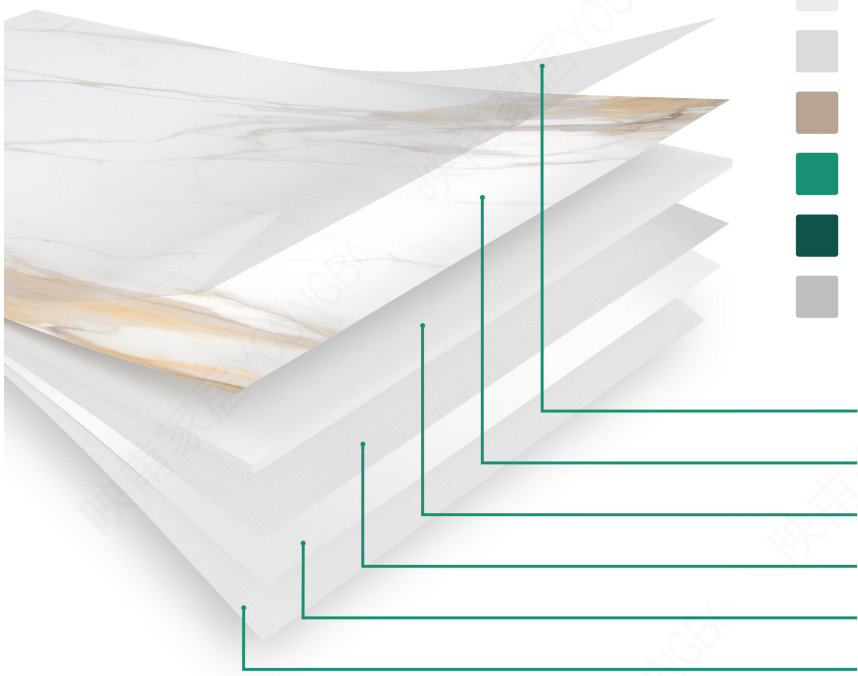

- 镜面高光PET表层
- 高清彩膜层
- 聚乙烯泡棉基材
- 环保热熔胶
- 防潮增韧铝膜底
- 离型层

1 材料特性

SPE材料主成分是聚乙烯，这种复合材料兼具两种材料的优点，如耐高低温性、抗老化性和聚乙烯的轻便性、易加工性。SPE材料环保无毒，不含有害物质，如甲醛、重金属等，对人体和环境友好。

2 产品优点

具有良好的耐水性、耐酸碱性、耐高低温性，适用于室内外各种环境条件，包括高湿度和极端气候区域。防霉变、防腐蚀，适合用于卫生间、厨房等潮湿环境，不易脱落或变形。表面可进行多种处理，如印花、压纹、喷涂等，实现丰富的视觉效果和触感体验，满足不同装修风格的需求。

3 应用场景

适用于家庭、办公室、酒店、商业空间等多种场合的墙面装饰，尤其适用于电视背景墙、卧室墙面、客厅墙面等需要提升美观度的区域。由于其优良的耐候性和耐久性，也常用于室外墙面装饰，如别墅外墙、商铺门面等。

4 市场前景

SPE装饰墙贴因其环保、耐用和装饰性等优点，市场需求持续增长。随着人们对居住和工作环境美观性与实用性的双重需求增加，其应用范围将进一步扩大。技术创新和设计多样化也将推动产品的市场拓展，成为现代装饰材料的重要组成部分。

5 安装维护

安装简便，一般使用自带的粘性背胶或者额外的粘合剂即可固定在平整的墙面上。安装过程快捷方便，不需要复杂工具。维护简单，表面可用湿布擦洗，对于顽固污渍可用中性清洁剂清洗，保持墙面干净整洁。

SPE装饰墙贴



1 自带背胶

撕开即贴 告别繁琐施工
一个人也可以轻松安装



2 防水防污

不怕潮湿 防止发霉保护
家具



3 防刮耐磨

表面覆膜使用更长久

4 加厚设计

升级加厚设计 经久耐用
放心使用寿命更长



SPE装饰墙贴



SPE装饰墙贴



PU文化石

产品概述

PU文化石的结构是由聚氨酯材料通过模具压制和发泡成型的轻质、环保、耐用的仿石材饰面材料。PU文化石不仅具有多种优越的物理和化学性能，而且以其逼真的外观和便于安装的特性，在建筑装饰领域中得到广泛应用。

产品结构

1 基材层

PU文化石的基材层主要由聚氨酯构成。聚氨酯全称为聚氨基甲酸酯，是一种高分子材料，由有机二异氰酸酯或多异氰酸酯与二羟基或多羟基化合物加聚而成。这种材料具有良好的耐温性，使用寿命较长，同时无污染、无毒无味，对环境友好。

2 颜色层

PU文化石在生产过程中采用模具内上色的方式，确保每一块文化石的颜色均匀且持久。同一类外观的PU文化石通常会研发2~4副模具，以达到更逼真的拼接效果。这些模具的造型均根据真实的石材打模而成，使得产品在外观上与真石材难以区分。

3 结构层

为了增强PU文化石的耐候性和耐用性，其表面会喷涂多层高强度涂料。这些涂料可以有效防止紫外线、酸雨等环境因素的侵蚀，从而延长其使用寿命。同时，PU文化石的设计为内卡结构，有舌头边、满槽和预留缝，使得大部分工作不需要嵌缝，可直接用螺丝和枪钉来完成

生产工艺

1 原材料准备

主要原料为聚氨酯，需要通过硅胶复制大自然中的岩石，再用泥模做成模种，进而浇筑出PU发泡用的铝模。

2 模具制作

根据真石材打造多副模具，确保拼接效果逼真。模具内喷涂脱模剂与底漆，然后倒入原材料进行发泡。

3 发泡成型

在模具内进行发泡，形成文化石的基础形状和质感。发泡完成后取出并进行表面喷涂，使产品具备防腐、耐老化的特性。

4 表面处理

喷涂外墙防水的水性环保涂料，增强PU文化石的耐候性和耐用性。

总的来说，PU文化石作为一种优质的装饰材料，不仅具有天然石材的美观和设计感，而且兼顾了轻量化、易安装、绿色环保等多种现代建筑需求的特点。其在生产工艺上的优势，使得PU文化石成为现代内外墙面装修的理想选择之一。

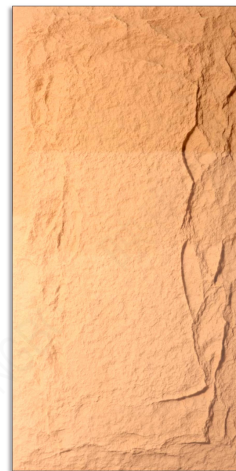

PU文化石凭借其基材层、颜色层、结构层等多重优势，成为了现代建筑装饰中不可或缺的优质材料。未来，随着科技的不断进步和市场需求的不断扩大，PU文化石有望在更多领域展现其独特的魅力。

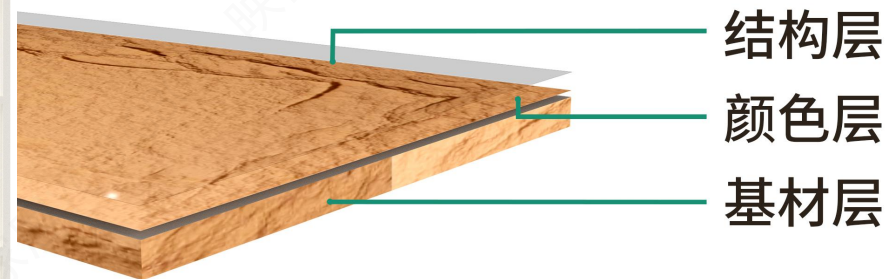

结构层
颜色层
基材层

PU文化石

PU石皮

尺寸:

2400*600

2400*800

1200*600

400*400

(两种版面可选
多种颜色可选择)



PU文化石

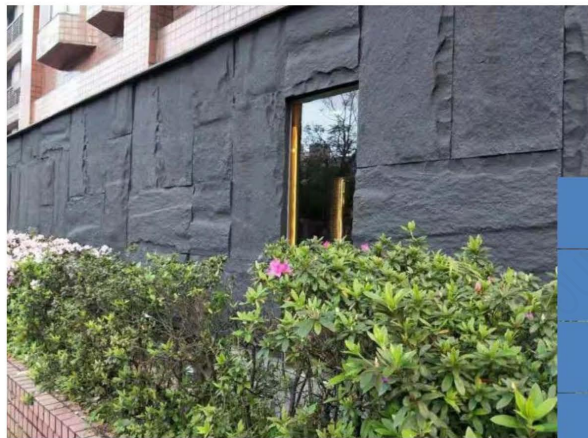

室外可用



客厅可用

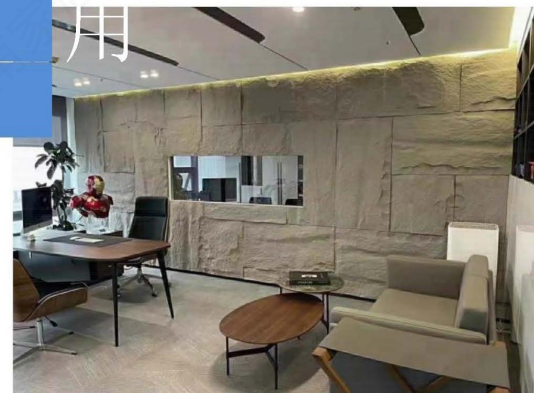

PU文化石

PU大板

尺寸:

2400*600

2400*800

(两种版面可选
多种颜色可选择)

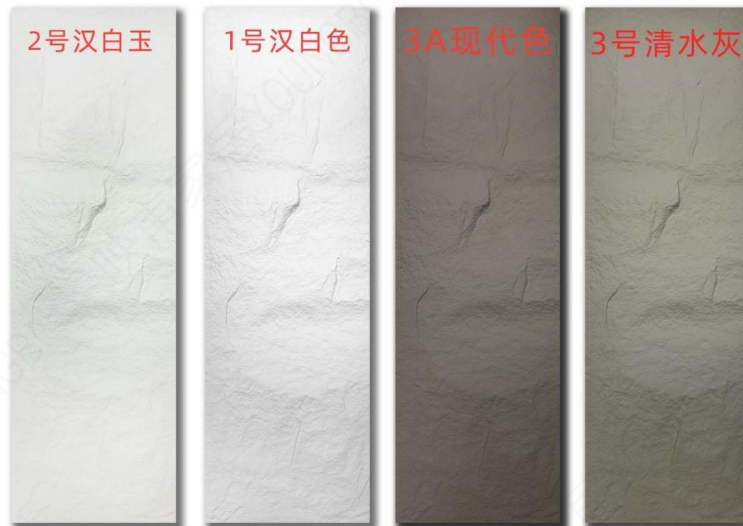

Pu攀岩石

尺寸:

2400*600

1200*600

(一种版面可选
多种颜色可选择)

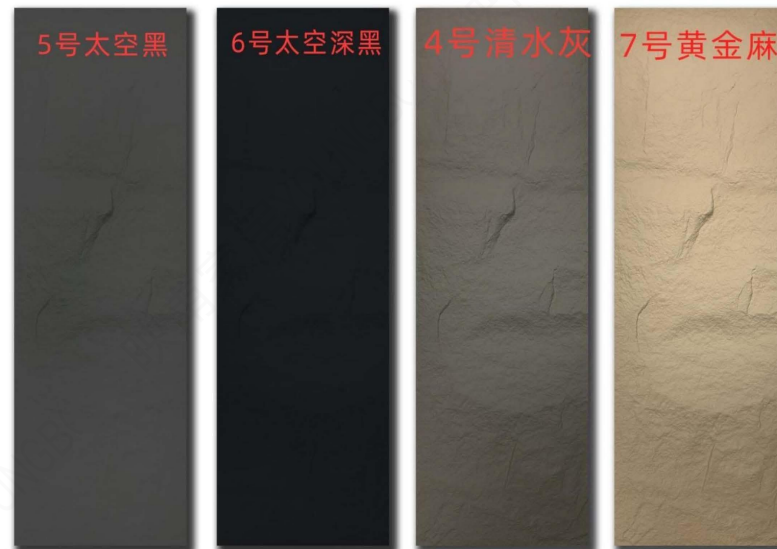

PU文化石

Pu流水
石尺寸:

1200*600

(两种版面可选
多种颜色可选择)

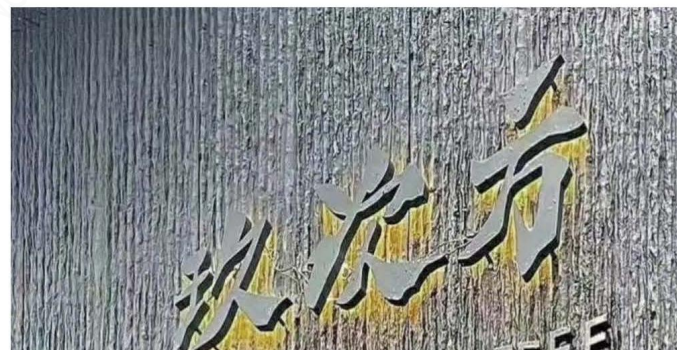
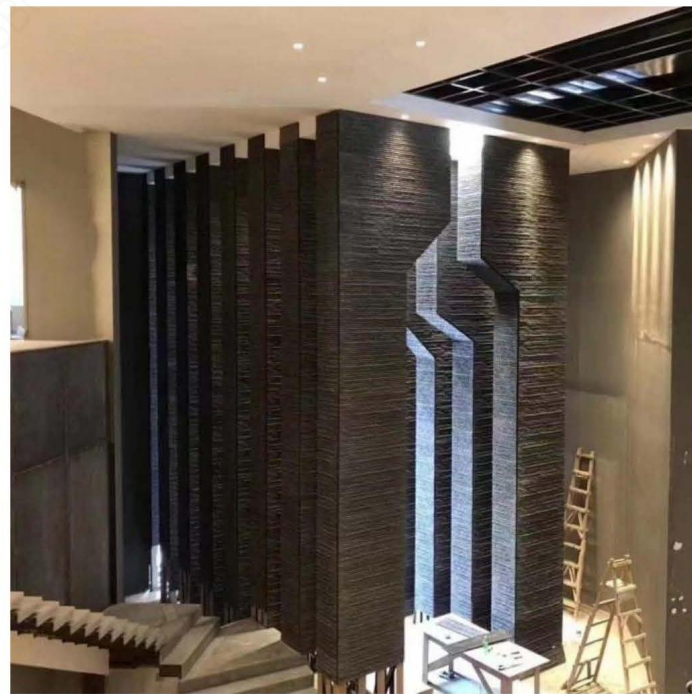
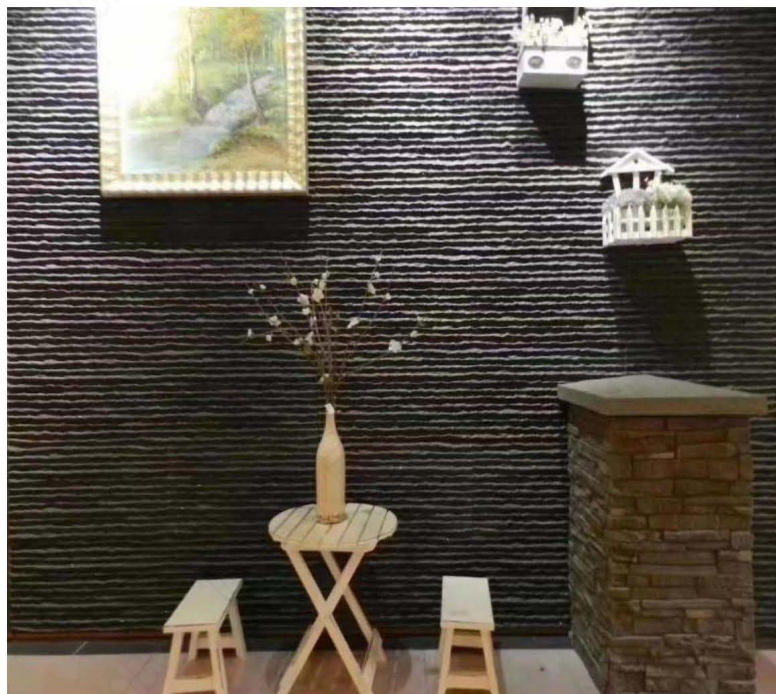
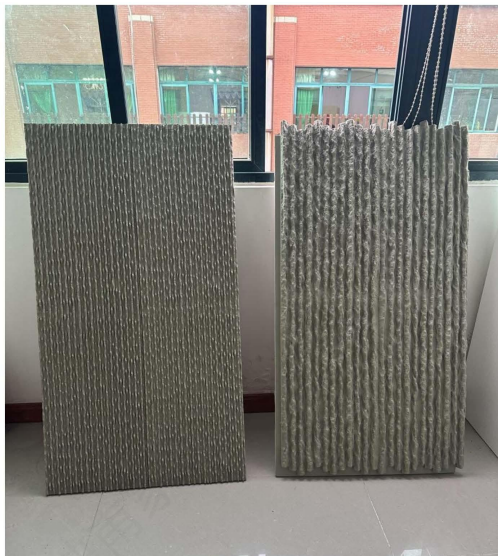

PU文化石

PU九宫格仿古砖

APPLICABLE SCENE

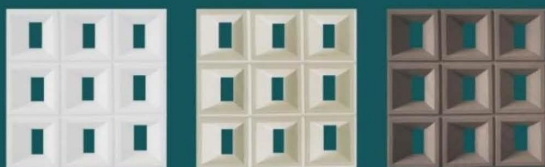

汉白色

汉白玉

清水灰

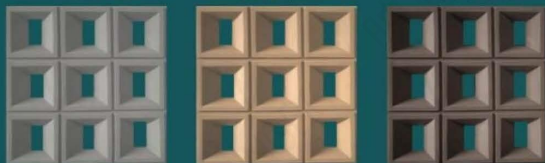

3A现代灰

黄金麻

清水深灰



太空黑

太空深黑

爱马仕红

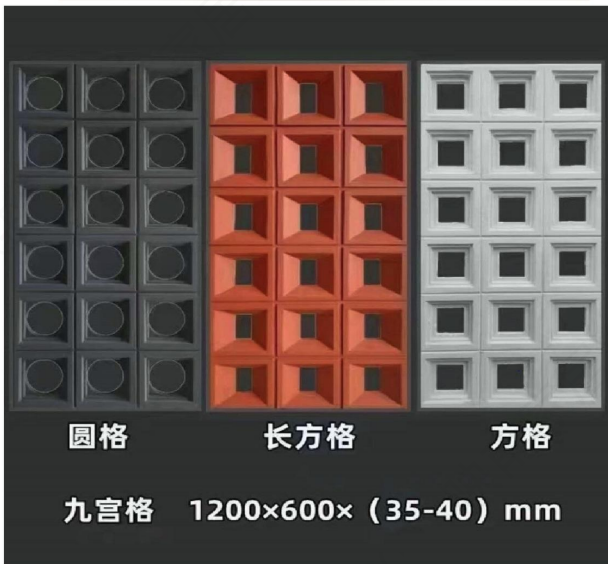

圆格

长方格

方格

九宫格 1200×600×(35-40) mm

PU九宫格尺寸: 1200*600mm 600*600mm

单面双面可选

三种版面可选

多种颜色可选



2A色



爱马仕红



靛黑



汉白玉

PU文化石

PU实心款构件：

尺寸：1200mm*600mm

单面款：厚度35mm

双面款：厚度70mm

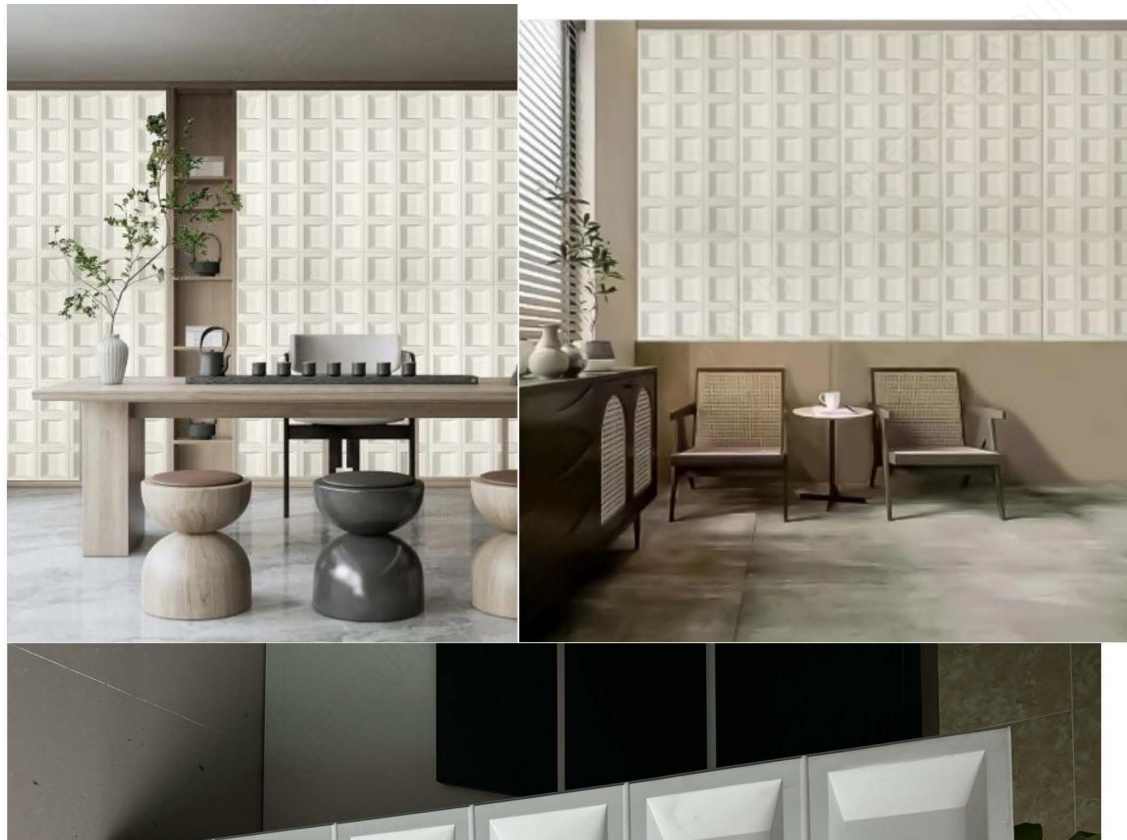
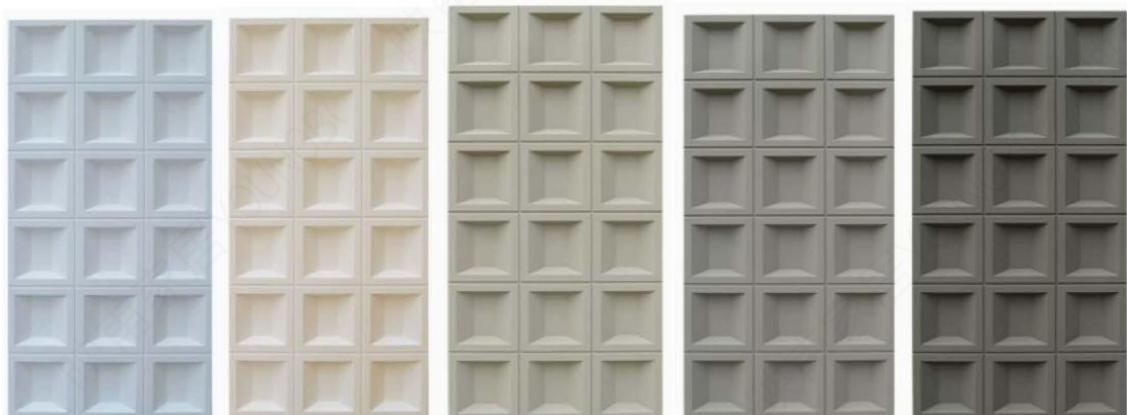

PU文化石

PU面包石:

尺寸: 1200mm*600mm

厚度35mm

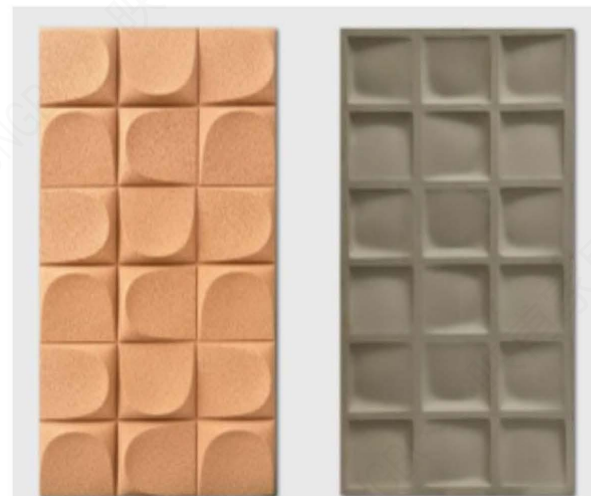
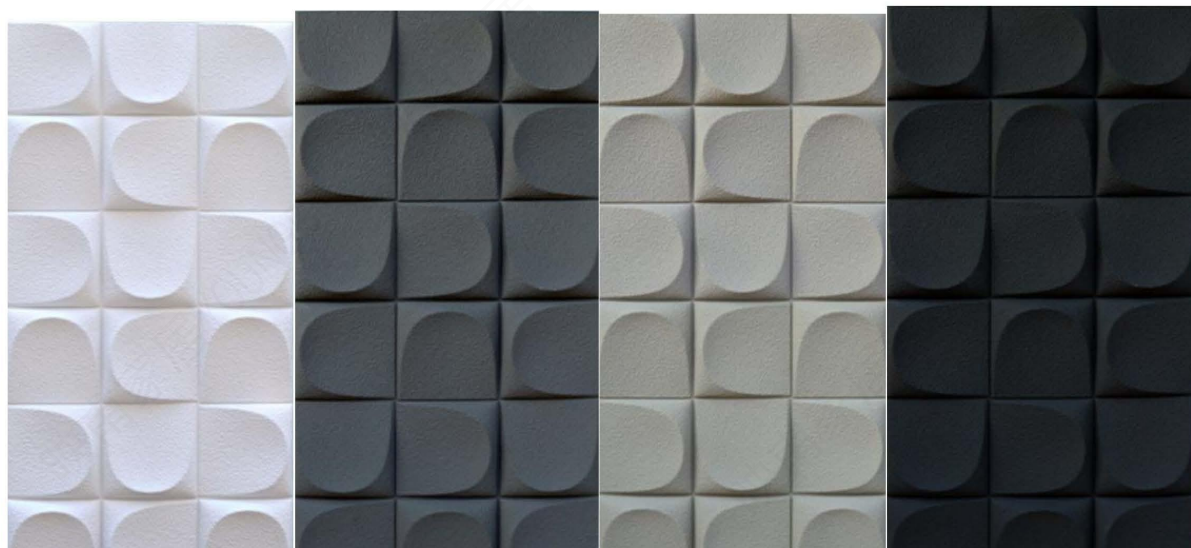

正面

背面



PU文化石

PU未来石:

尺寸: 1200mm*600mm

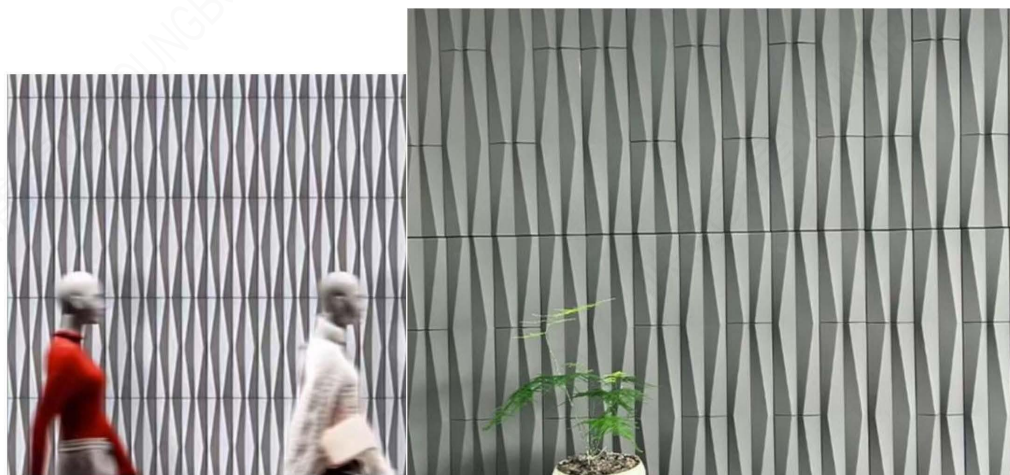
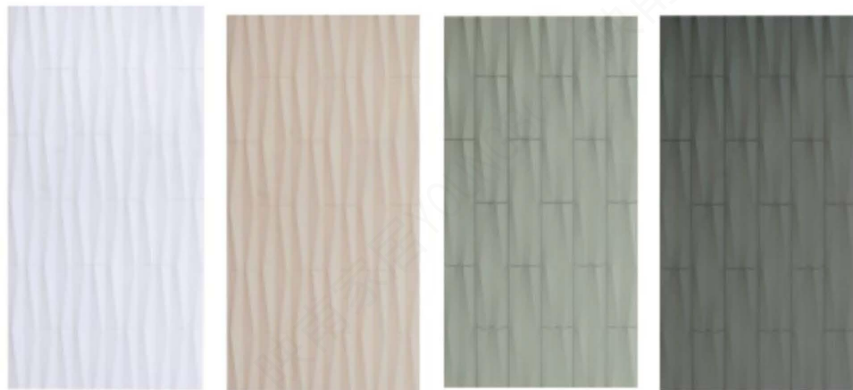

PU月球石

尺寸: 1200*600mm
2400*600mm

厚度: 20-50mm

颜色: 8个色系可选

颜色以实物为准

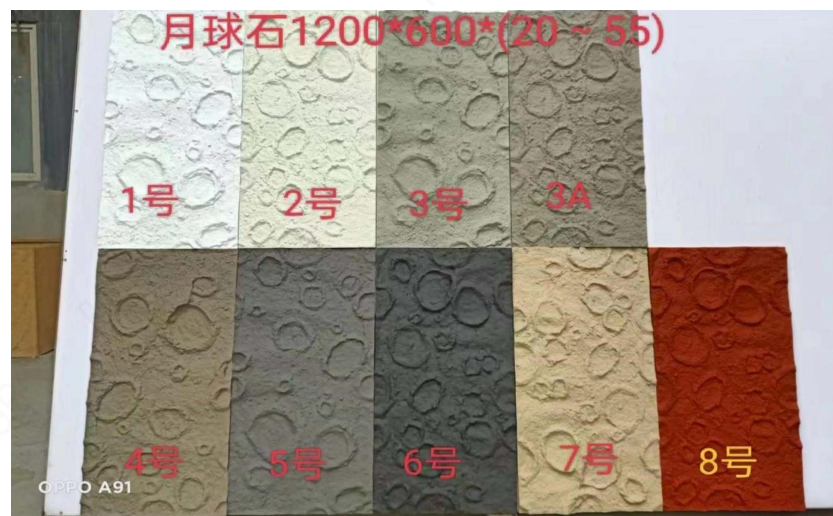
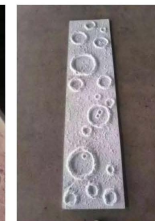

WPC格栅墙板

产品概述

WPC格栅墙板的结构主要由木粉、塑料和添加剂等组成，具有多层复合结构，包括基材层、装饰层、耐磨层以及可能的底层材料。

产品结构

1 基材层

材料组成：基材层通常由木粉和热塑性塑料（如聚氯乙烯PVC）混合制成，形成坚固的基层。
功能特点：这一层负责提供支撑和承重能力，同时具有良好的刚度和韧性，不易变形或龟裂。

2 装饰层

多样纹理：装饰层通过印刷技术复制各种纹理，如木纹、石纹、地毯纹等。
视觉效果：这一层直接决定了墙板的外观，通过高科技的印刷技术，可以实现极为逼真的装饰效果，满足不同消费者的需求。

3 耐磨层

材质厚度：通常采用透明的高分子PVC材料，厚度在0.3mm至0.7mm之间。
功能特点：这一层具有超强的耐磨性，能够有效减少日常使用中的磨损，延长墙板的使用寿命。同时，它还具备一定的抗污染能力，便

4 底层材料

结构类型：底层材料可能包括额外的隔音层或增强稳定性的层，具体根据产品的设计需求而定。
功能作用：底层材料的存在使得墙板在安装和使用过程中更加稳定，同时对下层的声音和震动具有良好的隔绝效果。

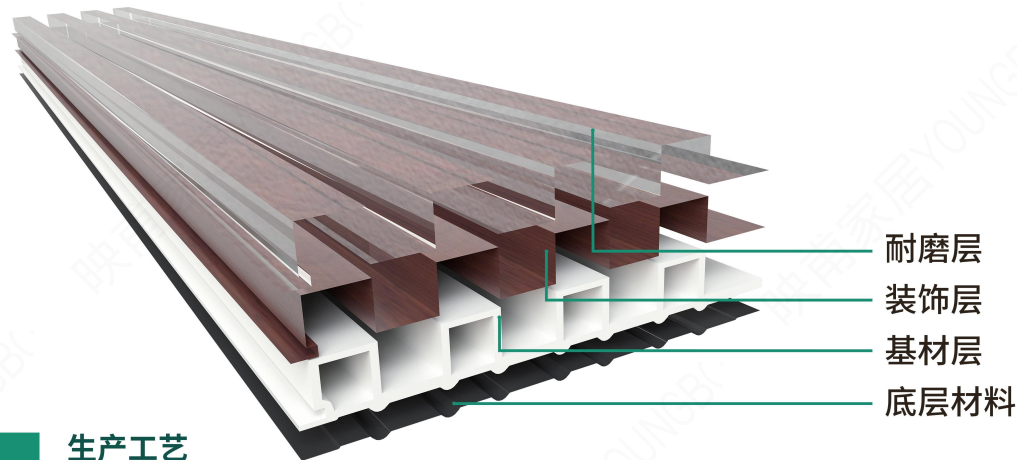

生产工艺

1 原材料准备

材料选择：主要原材料包括回收的塑料颗粒和木纤维，这些材料经过筛选和预处理，确保质量合格。
配料混合：将塑料颗粒和木纤维按照一定比例混合，并添加必要的稳定剂、润滑剂和抗氧化剂等助剂。

2 混合造粒

混合造粒：使用高速加热冷却混合机对混合物进行均匀混合，然后通过锥双木塑造粒机组进行造粒，形成用于挤出的原料颗粒。
设备要求：适合此流程的设备包括不锈钢三级风送系统和日产2-4吨的造粒设备。

3 挤出成型

挤出工艺：将造好的木塑颗粒投入挤出机，通过高温和压力将其挤出成所需的格栅形状。
温度控制：在挤出过程中需精确控制温度，以确保材料的流动性和成型质量。

4 冷却定型

冷却处理：挤出后的格栅墙板需要经过冷却定型处理，以确保其尺寸稳定性和形状精度。
设备支持：可以使用冷却水槽或冷却风刀对产品进行快速冷却。

5 后期处理

表面处理：根据需要对格栅墙板进行表面处理，如喷涂防水涂层或进行纹理加工，以提升产品的美观性和耐久性。
切割打包：对成品进行切割，确保尺寸符合要求，并进行质量检验，最后打包入库。

WPC格栅墙板



WALL CLADDING 格栅

格栅是一种三维墙板，拥有着独特线条美的，具体通风性好，可塑性好，美观性强，稳定性能强的优点，广泛应用于门边，墙板，电视背景墙。让整个的空间拥有着属于自己的个性。



WPC格栅墙板

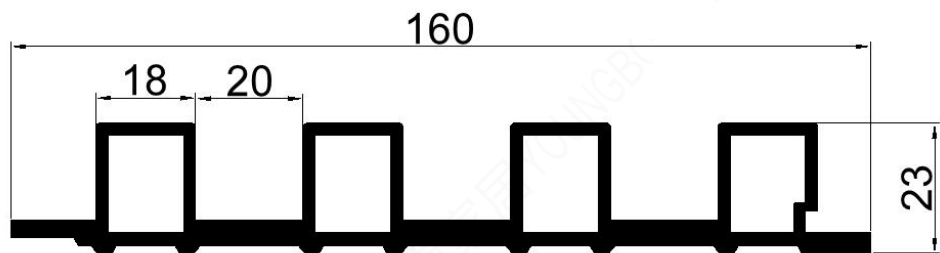

Product Description 产品规格

尺寸: 160*23*2800mm;定制

Size: 160*23*2800mm;customized

表面: 见膜皮表 (可定制)

Surface: Customized (film catalogue)

材质: WPC+PVC

Material: WPC+PVC

特点: 防水防火, 防虫, 易清理, 易于安装, 现代化设计, 环保

Features: Water Proof, Fire Proof, Anti Insect, Easy Clean,

Easy Installation, Modern Fashion Design, Environmental .



WPC格栅墙板

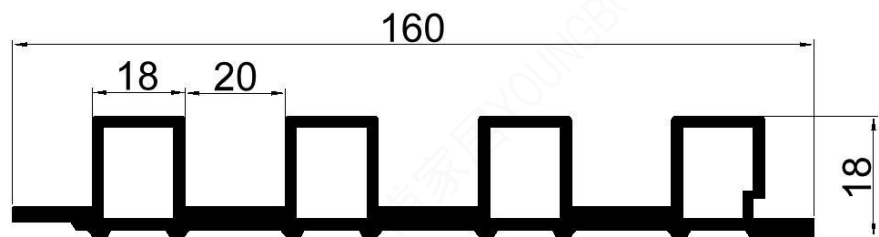

Product Description 产品规格

尺寸: 160*18*2800mm;定制

Size: 160*18*2800mm;customized

表面: 见膜皮表 (可定制)

Surface:Customized (film catalogue)

材质: WPC+PVC

Material:WPC+PVC

特点: 防水防火, 防虫, 易清理, 易于安装, 现代化设计, 环保

Features: Water Proof, Fire Proof, Anti Insect, Easy Clean,

Easy Installation, Modern Fashion Design, Environmental .



WPC格栅墙板

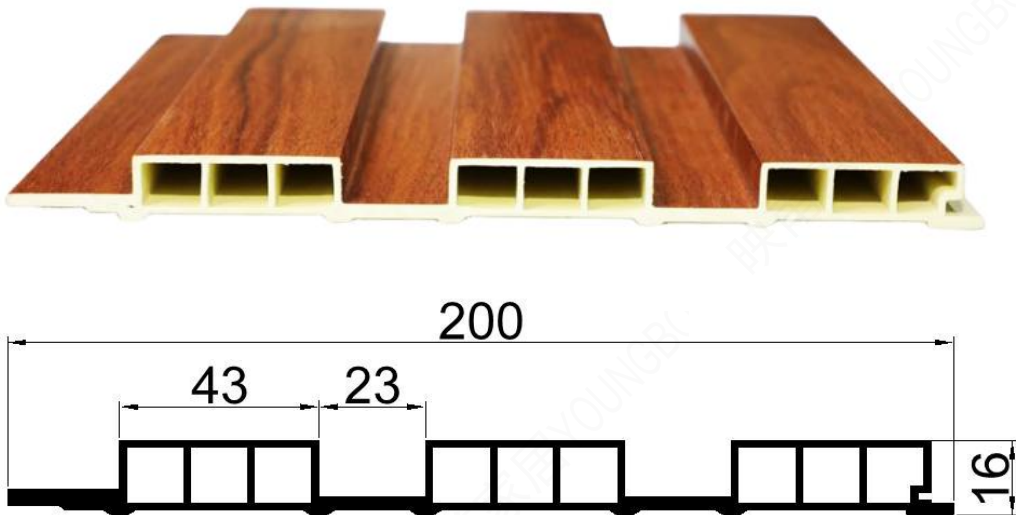

Product Description 产品规格

尺寸: 200*16*2800mm;定制

Size: 200*16*2800mm;customized

表面: 见膜皮表 (可定制)

Surface:Customized (film catalogue)

材质: WPC+PVC

Material:WPC+PVC

特点: 防水防火, 防虫, 易清理, 易于安装, 现代化设计, 环保

Features: Water Proof, Fire Proof, Anti Insect, Easy Clean,

Easy Installation, Modern Fashion Design, Environmental .



WPC格栅墙板

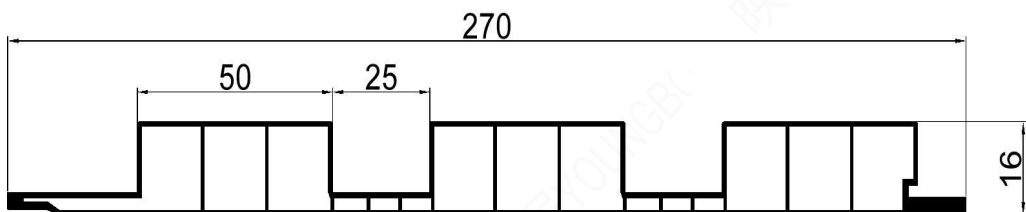

Product Description 产品规格

尺寸: 270*16*2800mm;定制

Size: 270*16*2800mm;customized

表面: 见膜皮表 (可定制)

Surface:Customized (film catalogue)

材质: WPC+PVC

Material:WPC+PVC

特点: 防水防火, 防虫, 易清理, 易于安装, 现代化设计, 环保

Features: Water Proof, Fire Proof, Anti Insect, Easy Clean,

Easy Installation, Modern Fashion Design, Environmental .



WPC格栅墙板

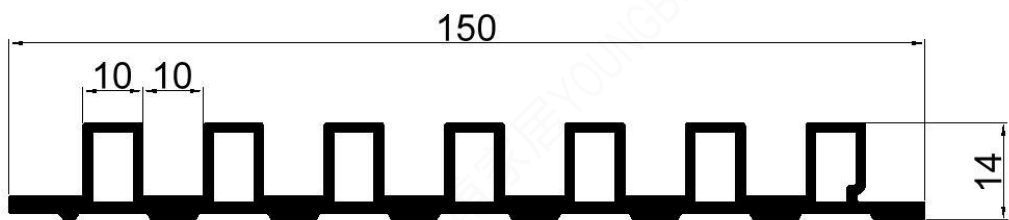
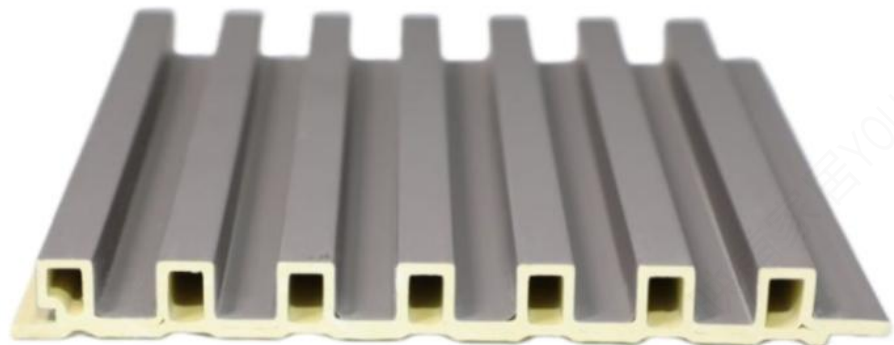

Product Description 产品规格

尺寸: 150*14*2800mm;定制

Size: 150*14*2800mm;customized

表面: 见膜皮表 (可定制)

Surface:Customized (film catalogue)

材质: WPC+PVC

Material:WPC+PVC

特点: 防水防火, 防虫, 易清理, 易于安装, 现代化设计, 环保

Features: Water Proof, Fire Proof, Anti Insect, Easy Clean,

Easy Installation, Modern Fashion Design, Environmental .

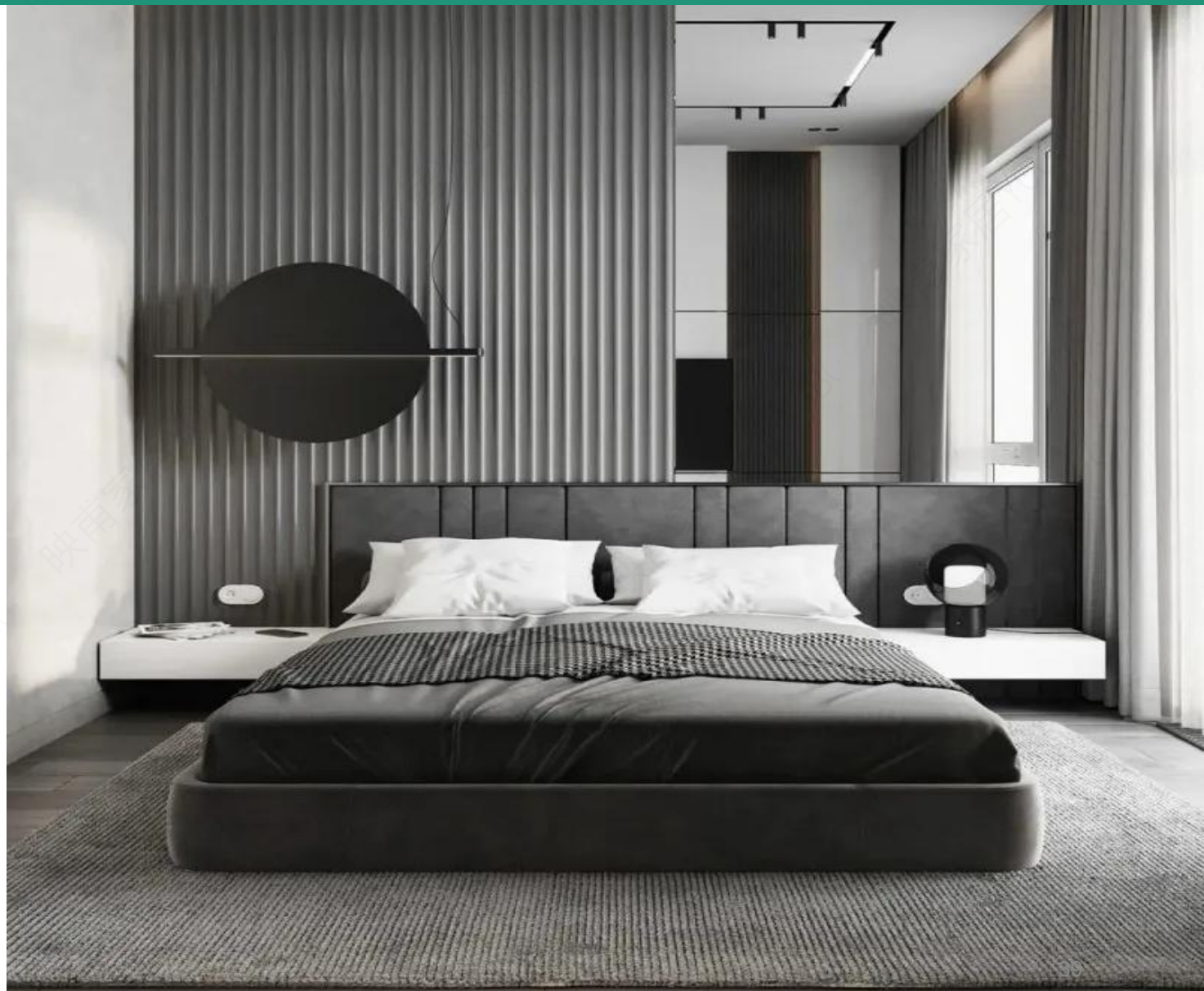

WPC格栅墙板

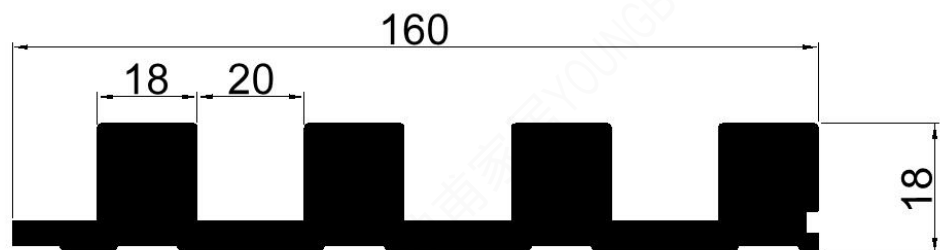

Product Description 产品规格

尺寸: 160*18*2800mm;定制

Size: 160*18*2800mm;customized

表面: 见膜皮表 (可定制)

Surface:Customized (film catalogue)

材质: WPC+PVC/WOOD

Material:WPC+PVC/WOOD

特点: 防水防火, 防虫, 易清理, 易于安装, 现代化设计, 环保

Features: Water Proof, Fire Proof, Anti Insect, Easy Clean,

Easy Installation, Modern Fashion Design, Environmental .



户外木塑地板

产品概述

户外木塑地板是一种由塑料和木质纤维混合制成的复合材料，具有多种优良特性。在现代建筑和园林景观中得到了广泛的应用。

生产工艺

1 原材料准备

木材纤维和塑料的选择：木塑地板的主要原料包括木材纤维和塑料。木材纤维可以是锯末、木屑等木材废料，塑料主要采用高密度聚乙烯（HDPE）、聚氯乙烯（PVC）等热塑性塑料。这些材料需要经过质检合格后，进行必要的预处理，如制粒、研磨等，以确保其质量和后续加工的顺利进行。

2 原料混合

将准备好的木材纤维和塑料颗粒按照一定的比例投入到高速搅拌机中进行充分搅拌。混合过程中需要确保原料均匀分布，以便后续的挤出成型工艺能够顺利进行。根据产品的不同需求还可以在混合过程中加入颜料、UV 防护剂等成分，以赋予地板不同的颜色和性能。

3 造粒

混合好的原料经过造粒，形成便于挤出成型的颗粒状物料。造粒过程可以进一步改善原料的混合效果，提高产品的质量稳定性。

4 挤出成型

将造粒后的木塑颗粒通过专业的木塑地板挤出机进行挤出成型。挤出机通常由加料系统、熔融系统、挤出模具、冷却定型装置等部分组成。在挤出过程中，木塑颗粒在高温高压下熔融塑化，然后通过模具挤出形成特定形状的板材。

5 真空定径冷却

挤出后的板材通过真空定径装置进行冷却定型。真空定径可以使板材的形状更加稳定，尺寸更加准确，并且可以减少板材内部的应力，提高其力学性能。

6 牵引与切割

经过冷却定型的板材通过牵引装置进行牵引，使其以一定的速度移动。在牵引过程中，可以根据需要对板材进行定长切割，以满足不同规格的需求。切割时需要使用专用的切割工具，确保切割面平整、无毛刺。

7 表面处理

切割后的木塑地板可以进行表面处理，以提高其美观性和耐候性。常见的表面处理方法包括砂光、压花、涂漆等。砂光可以使地板表面更加光滑，压花可以增加地板的防滑性能和装饰效果，涂漆则可以提高地板的耐候性和耐磨性。



产品结构及特性

1 材质构成

主要材料：由木材（木纤维素、植物纤维素）为基础材料与热塑性高分子材料（塑料）和加工助剂等混合制成。

2 基材结构分类

实心木塑地板：内部为实心的木塑复合材料结构，具有较高的强度和稳定性，适用于对承重要求较高的场所。

空心木塑地板：内部为空心的结构设计，相比实心地板更轻便，但承重能力相对较弱，适用于人流量较小的区域或装饰性较强的场所。

3 发泡与否分类

基材发泡木塑地板：在生产过程中对基材进行了发泡处理，使其具有一定的弹性和缓冲性能，能够提供更好的脚感舒适度。

基材不发泡木塑地板：基材没有经过发泡处理，质地相对较硬，但强度和耐磨性更高。

4 表面状态处理分类

素面木塑地板：表面未经特殊处理，保持了木塑材料的自然纹理和质感，具有朴实自然的外观。

涂饰木塑地板：在表面进行了涂饰处理，如涂漆、喷涂等，可以增加地板的美观度和耐用性，同时也可以根据需要定制不同的颜色和图案。

贴面木塑地板：在表面覆盖了一层贴面材料，如木皮、PVC 膜等，能够进一步提升地板的装饰效果和耐磨性。

5 颜色样式

颜色丰富：常见的颜色有柚木色、酒红色、咖啡色、灰色等，也可根据客户需求定制其他颜色。

样式多样：有圆孔拉丝、方孔开槽等不同样式，以及多种花纹可选，能够满足不同场所的装饰需求。



户外木塑地板



OUTDDOR BAORD 户外板

WPC板在户外甲板地板、围栏、屋顶和屋顶上有多种用途和应用，门窗框、户外景观等。它包括60%的木粉（纤维）、30%的HDPE或LDPE，其余10%为添加剂。耐磨，使用寿命长，防水防火，防虫，易清理，易于安装，现代化设计，环保。



户外木塑地板



Product Description 产品规格

尺寸: 150/140*23*2800mm;定制

Size: 140*23*2800mm;customized

表面: 见花色表 (可定制)

Surface:Customized (color catalogue)

材质: WPC+PVC/WOOD

Material:WPC+PVC/WOOD

特点: 防水防火, 防虫, 易清理, 易于安装, 现代化设计, 环保

Features: Water Proof, Fire Proof, Anti Insect, Easy Clean,

Easy Installation, Modern Fashion Design, Environmental .

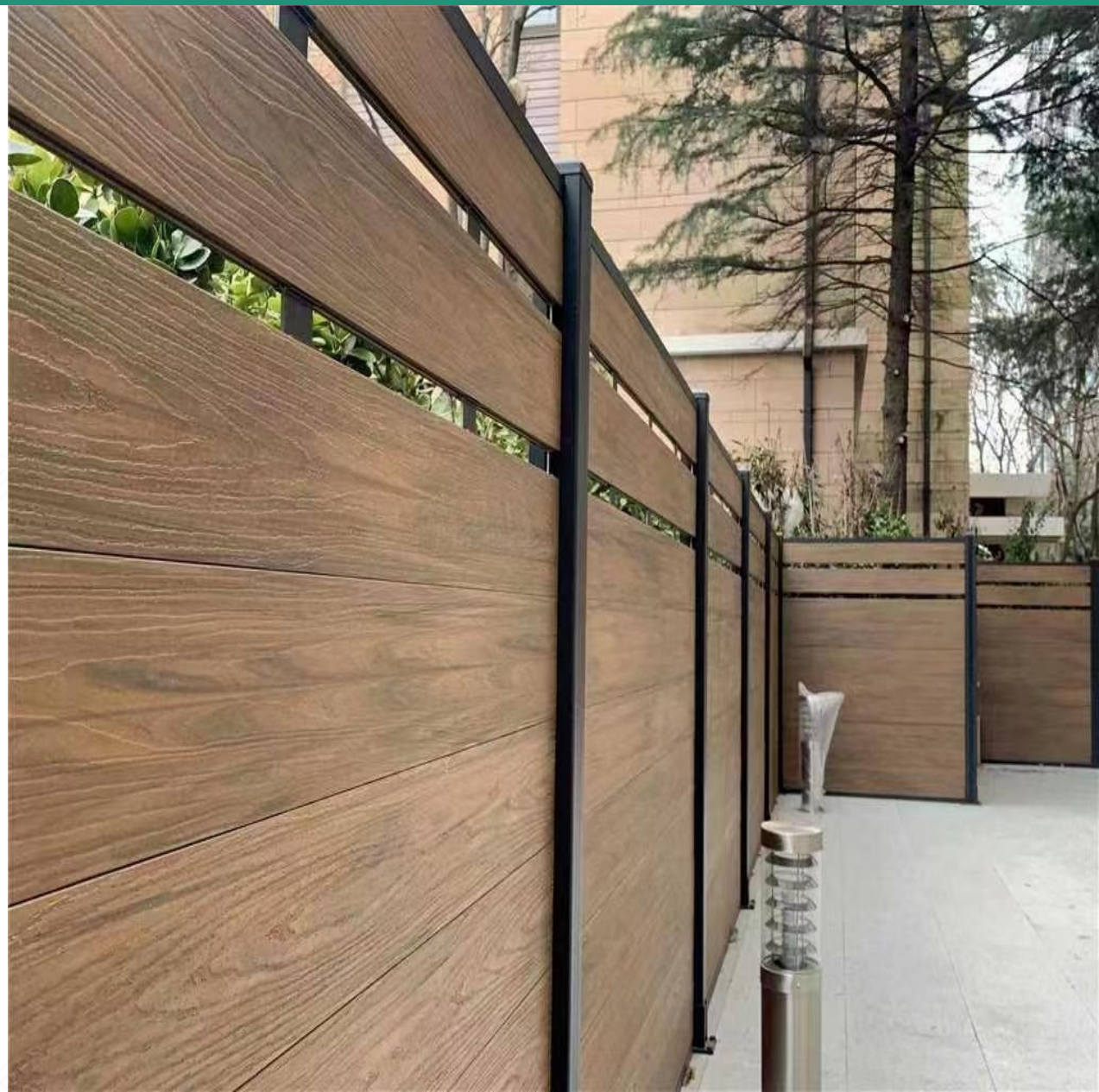

户外木塑地板



Product Description 产品规格

尺寸: 219*26*2800mm;定制

Size: 219*26*2800mm;customized

表面: 见花色表 (可定制)

Surface:Customized (color catalogue)

材质: WPC+PVC/WOOD

Material:WPC+PVC/WOOD

特点: 防水防火, 防虫, 易清理, 易于安装, 现代化设计, 环保

Features: Water Proof, Fire Proof, Anti Insect, Easy Clean,

Easy Installation, Modern Fashion Design, Environmental .



户外木塑地板



Product Description 产品规格

尺寸: 195*25*2800mm;定制

Size: 195*25*2800mm;customized

表面: 见花色表 (可定制)

Surface:Customized (color catalogue)

材质: WPC+PVC/WOOD

Material:WPC+PVC/WOOD

特点: 防水防火, 防虫, 易清理, 易于安装, 现代化设计, 环保

Features: Water Proof, Fire Proof,Anti Insect, Easy Clean,

Easy Installation, Modern Fashion Design, Environmental .

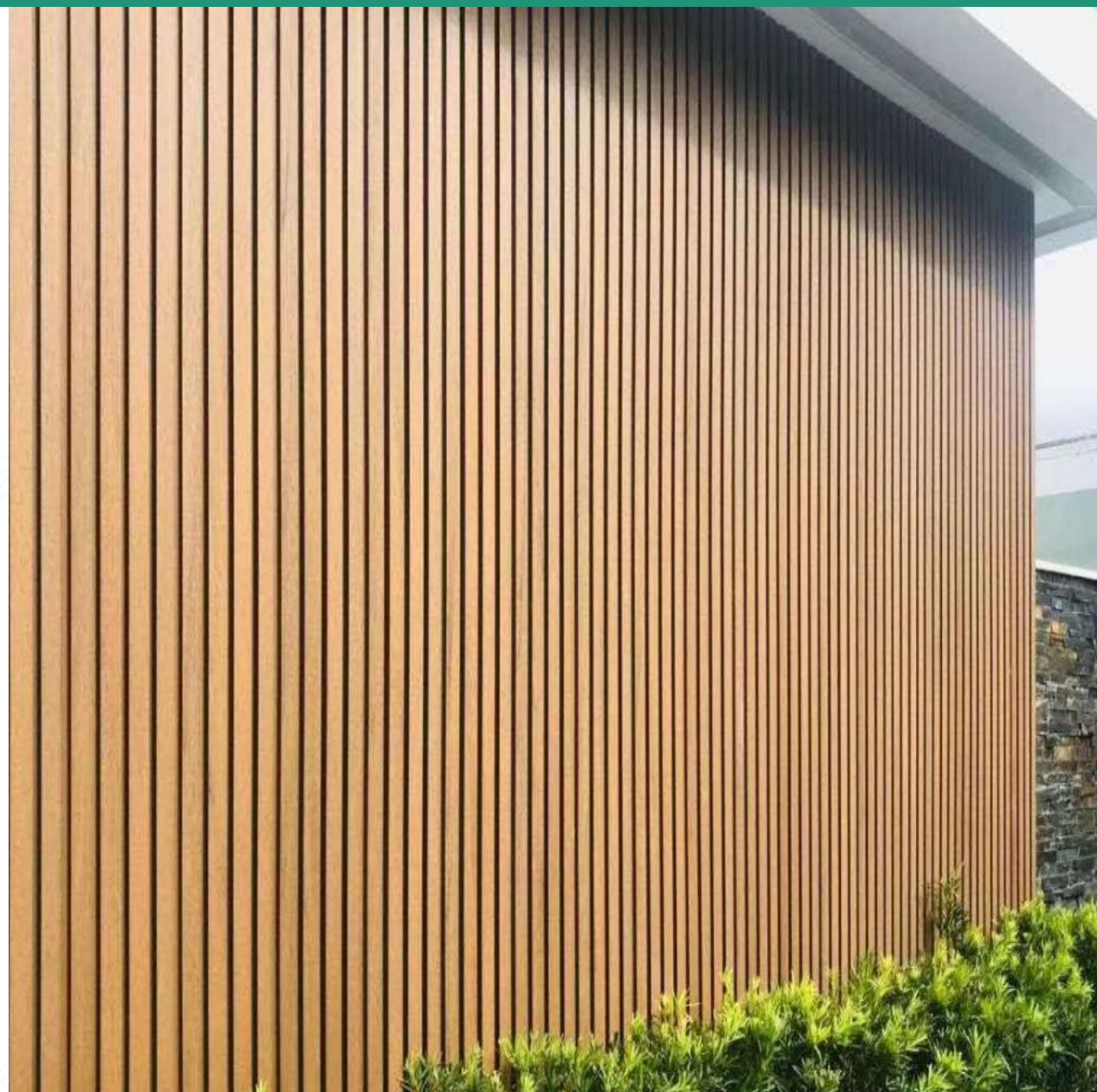

户外木塑地板



Product Description 产品规格

尺寸: 128*25*2800mm;定制

Size: 195*25*2800mm;customized

表面: 见花色表 (可定制)

Surface:Customized (color catalogue)

材质: WPC+PVC/WOOD

Material:WPC+PVC/WOOD

特点: 防水防火, 防虫, 易清理, 易于安装, 现代化设计, 环保

Features: Water Proof, Fire Proof,Anti Insect, Easy Clean,

Easy Installation, Modern Fashion Design, Environmental .



户外木塑地板



Product Description 产品规格

尺寸: 160*20*2800mm;定制

Size: 160*20*2800mm;customized

表面: 见花色表 (可定制)

Surface:Customized (color catalogue)

材质: WPC+PVC/WOOD

Material:WPC+PVC/WOOD

特点: 防水防火, 防虫, 易清理, 易于安装, 现代化设计, 环保

Features: Water Proof, Fire Proof, Anti Insect, Easy Clean,

Easy Installation, Modern Fashion Design, Environmental .



户外木塑地板



Product Description 产品规格

尺寸: 148*25*2800mm;定制

Size: 148*25*2800mm;customized

表面: 见花色表 (可定制)

Surface:Customized (color catalogue)

材质: WPC+PVC/WOOD

Material:WPC+PVC/WOOD

特点: 防水防火, 防虫, 易清理, 易于安装, 现代化设计, 环保

Features: Water Proof, Fire Proof, Anti Insect, Easy Clean,

Easy Installation, Modern Fashion Design, Environmental .

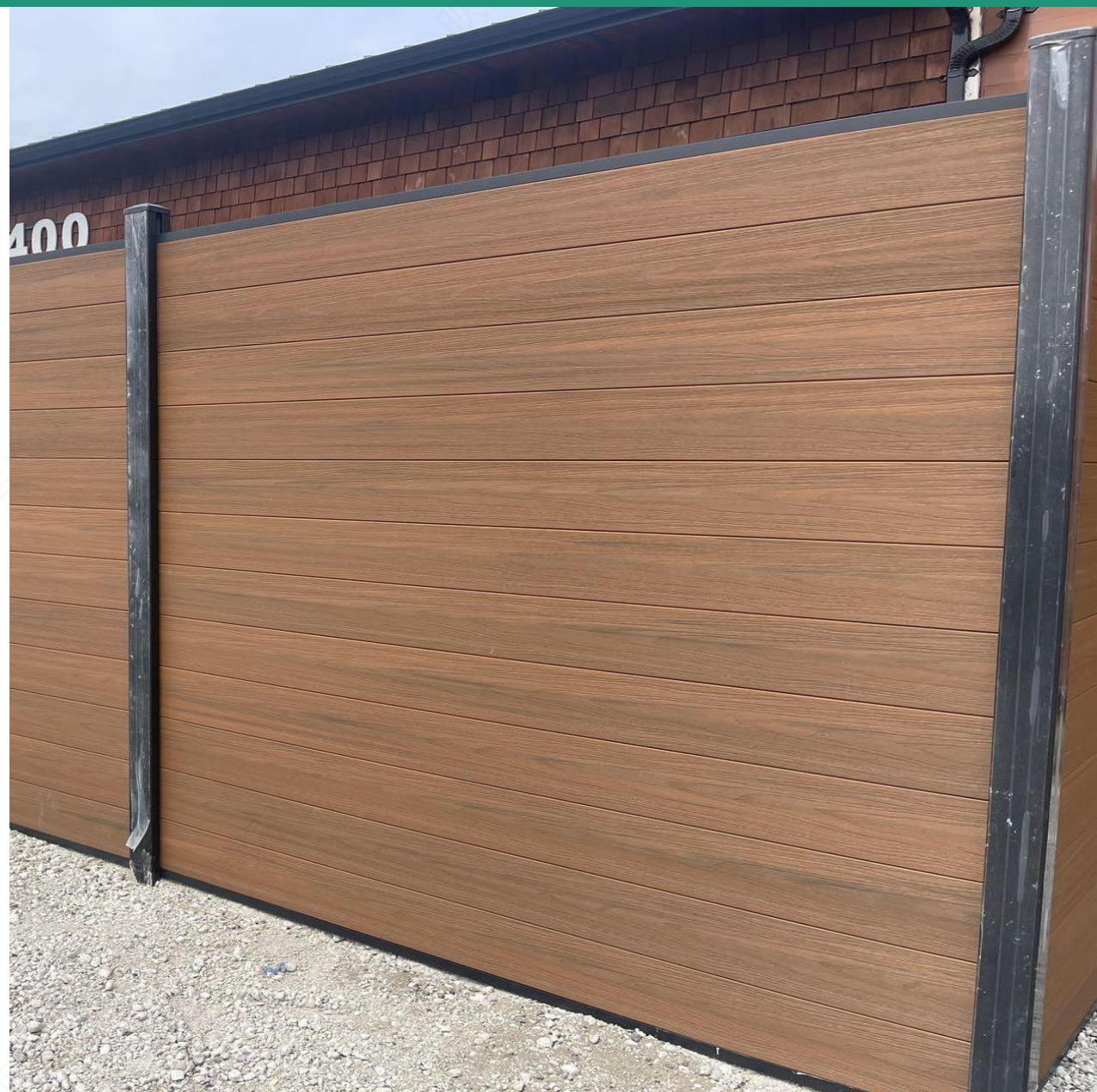

户外木塑地板

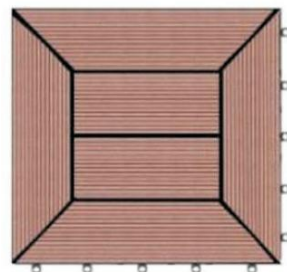
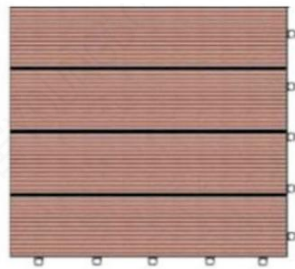
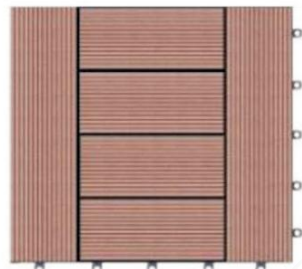
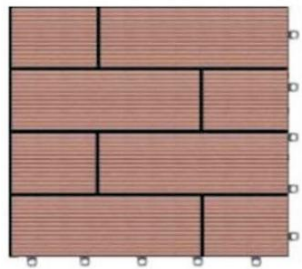

Product Description 产品规格

尺寸: 300*300mm;定制

Size:300*300mm;customized

表面: 见花色表 (可定制)

Surface:Customized (color catalogue)

材质: WPC+PVC/WOOD

Material:WPC+PVC/WOOD

特点: 防水防火, 防虫, 易清理, 易于安装, 现代化设计, 环保

Features: Water Proof, Fire Proof, Anti Insect, Easy Clean,

Easy Installation, Modern Fashion Design, Environmental .



竹木竹炭墙板



WALL PANEL 墙板

新型材料墙板是一种全新的环保材料，广泛应用于室内外装修，其特点为环保，无甲醛，防水防火，不易划伤，阻燃防潮，安装方便，可弯曲，多种开槽方式。满足不同用户不同风格的需求（木纹、布纹、肤质触感、金属表面等）大尺寸规格（2.4M-6M），适用于墙，顶，地，柜一体化应用



竹木竹炭墙板



Specification 尺寸规格

厚度：5mm;8mm;10mm;12mm;16mm;定制

Thickness: 5mm;8mm;10mm;12mm;16mm;customized

宽度：1220mm

Width: 1220mm

长度：2440mm;2800mm;3200mm;定制

Length: 2440mm;2800mm;3200mm;定制

表面：见膜皮表（可定制）

Surface: Customized (film catalogue)

特点：防水防火，防虫，易清理，易于安装，现代化设计，环保

Features: Water Proof, Fire Proof, Anti Insect, Easy Clean,

Easy Installation, Modern Fashion Design, Environmental .

Surface coating 表面包覆

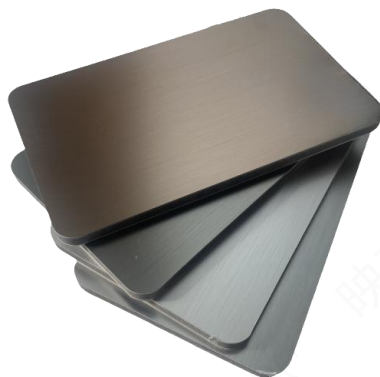

金属表面/METAL SURFACE



木纹表面/WOOD SURFACE

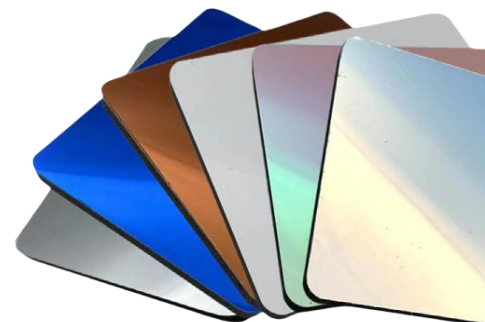

镜面表面/MIRROR SURFACE

竹木竹炭墙板

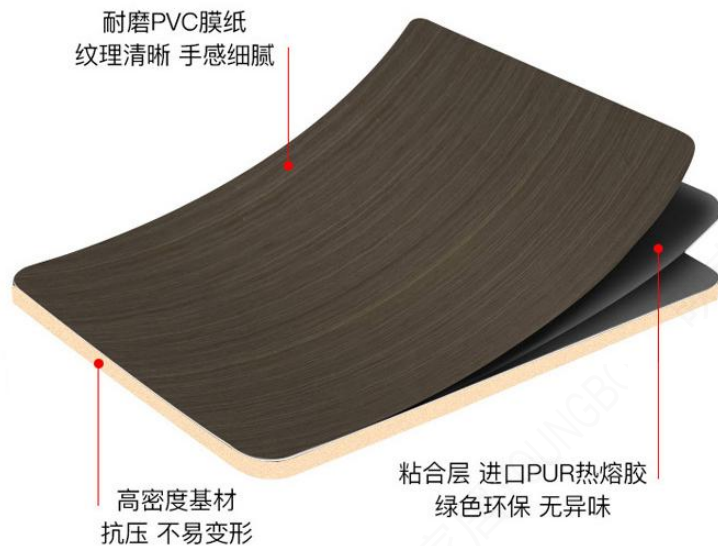

Specification 尺寸规格

厚度：5mm;8mm;10mm;12mm;16mm;定制

Thickness: 5mm;8mm;10mm;12mm;16mm;customized

宽度：1220mm

Width: 1220mm

长度：2440mm;2800mm;3200mm;定制

Length: 2440mm;2800mm;3200mm;定制

表面：见膜皮表（可定制）

Surface: Customized (film catalogue)

特点：防水防火，防虫，易清理，易于安装，现代化设计，环保

Features: Water Proof, Fire Proof, Anti Insect, Easy Clean,

Easy Installation, Modern Fashion Design, Environmental .



大理石表面/MARBLE STONE SURFACE



肤质表面/SKIN SURFACE



皮饰表面/CLOTH SURFACE

竹木竹炭墙板

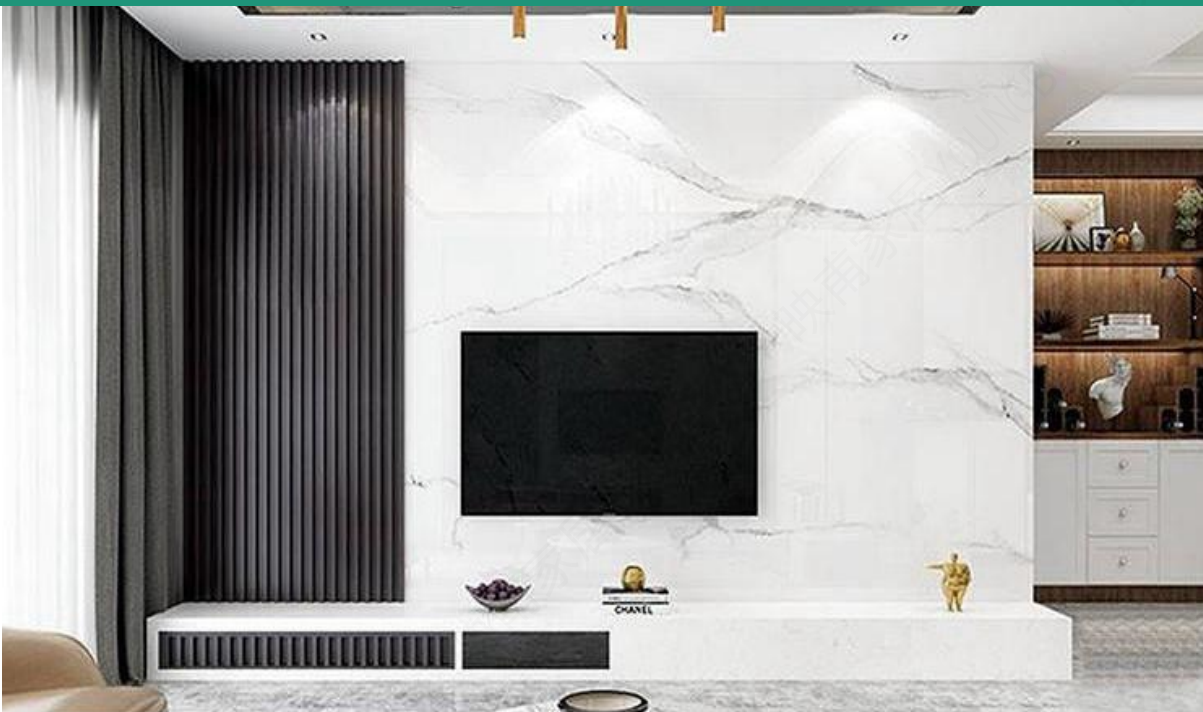

家居装饰/HOME ROOM

大理石表面/Marble surface

Sense of reality,
European and American style

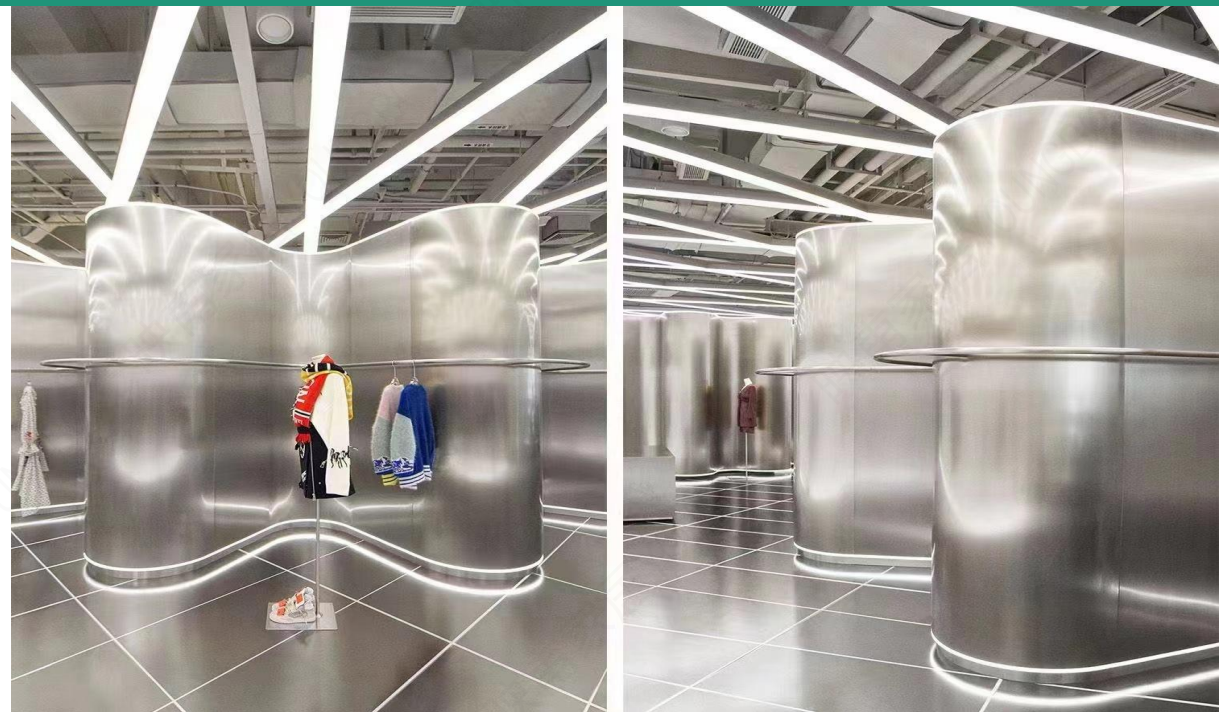

商场装饰/shopping mall

金属表面/Metal surface

Modern, scientific and technological

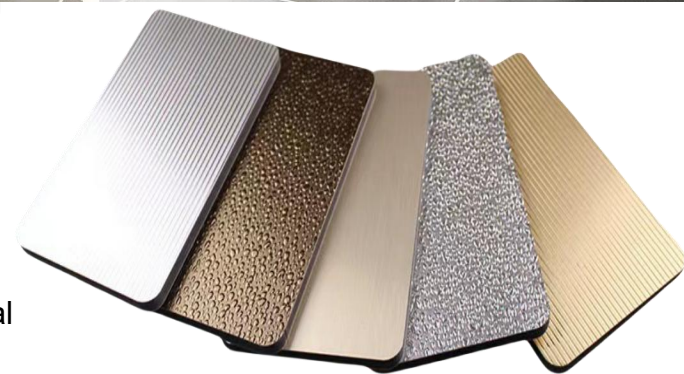

竹木竹炭墙板

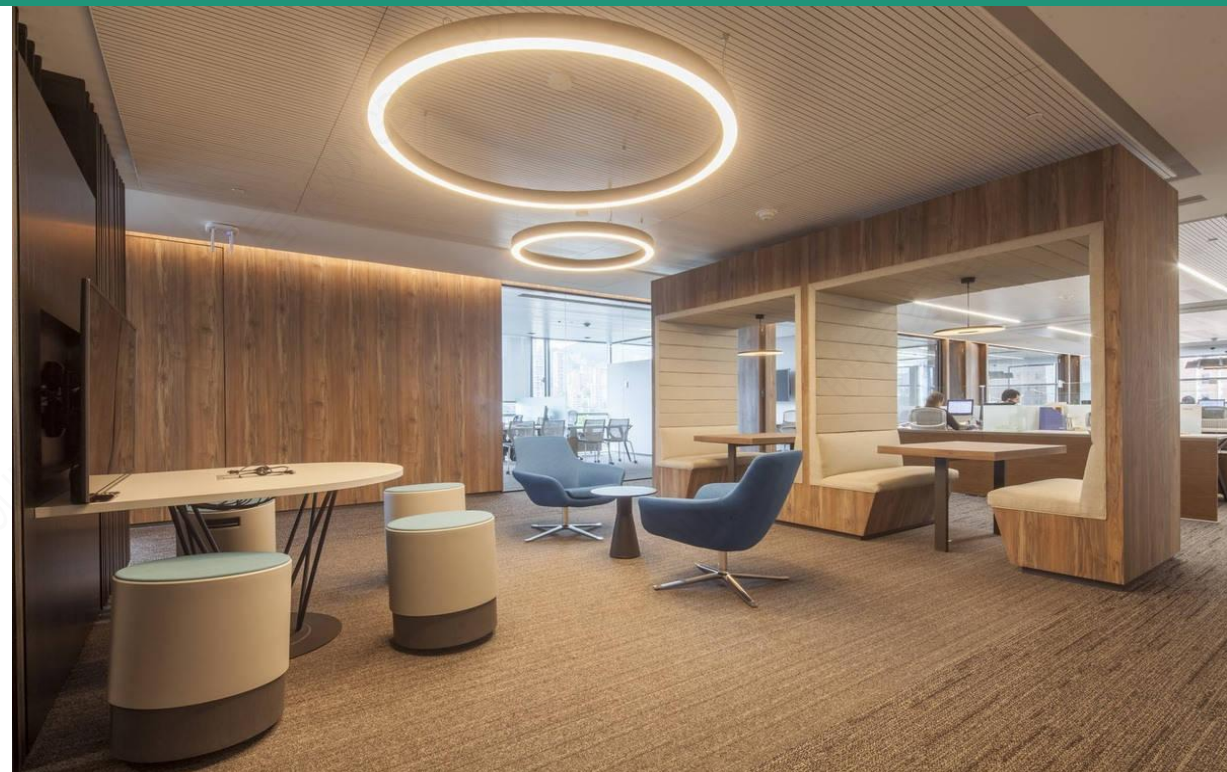
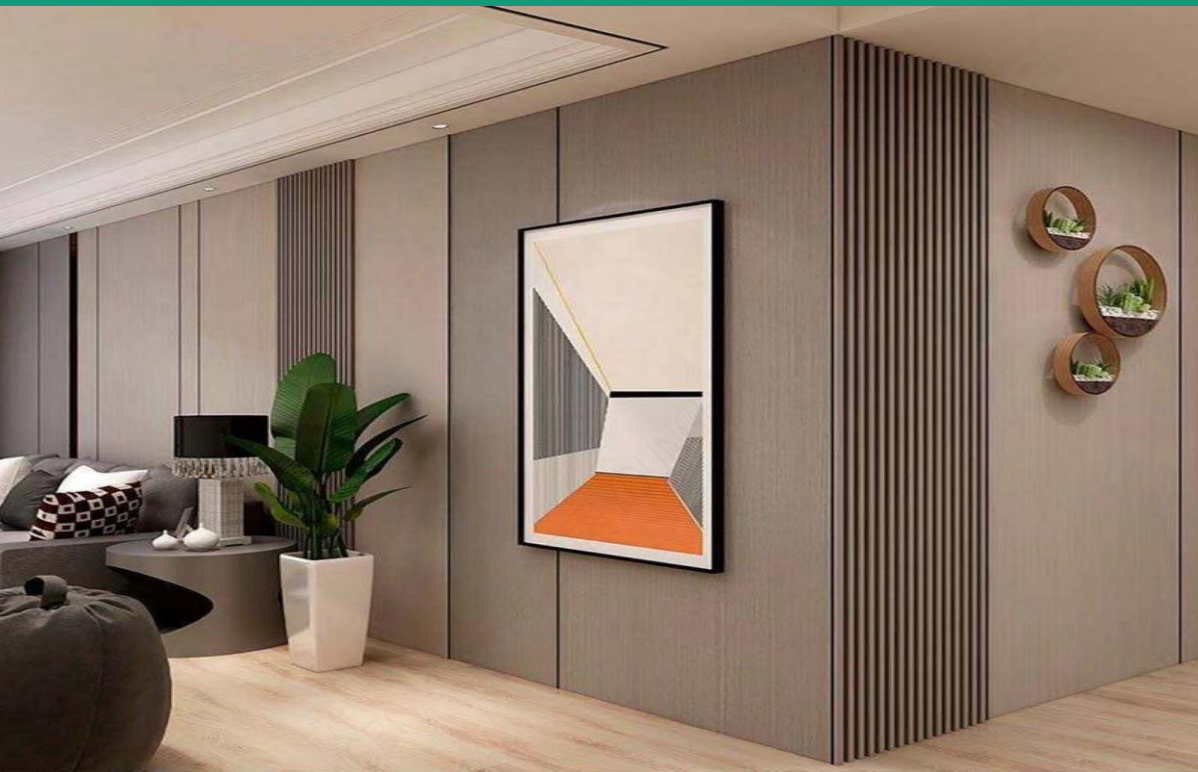

室内装饰/Interior

布饰表面/Cloth surface

Minimalism, literary atmosphere

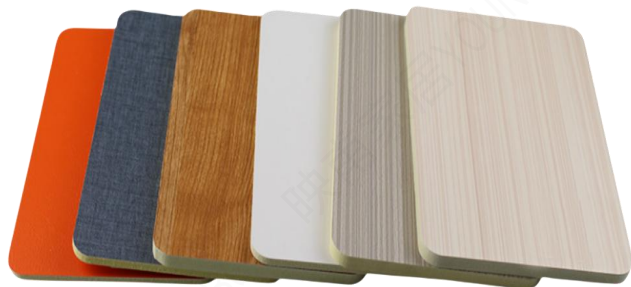

办公室/会议室
Office/conference room

木纹表面/WOOD SURFACE

Original sense of ecology, tranquility and environmental protection

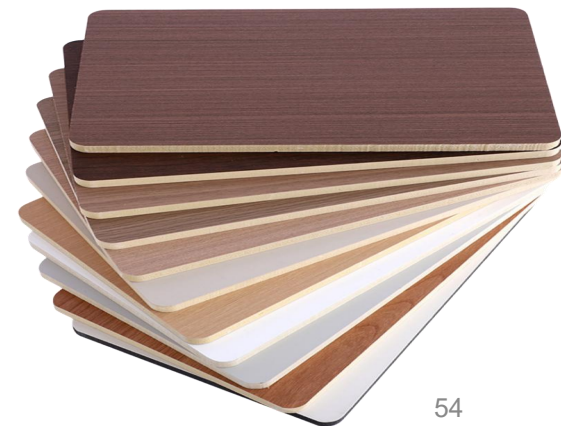

竹木竹炭墙板



Bionic original skin feeling,
Build the "second layer of
skin" of home"

肤质触感表面

Skin surface

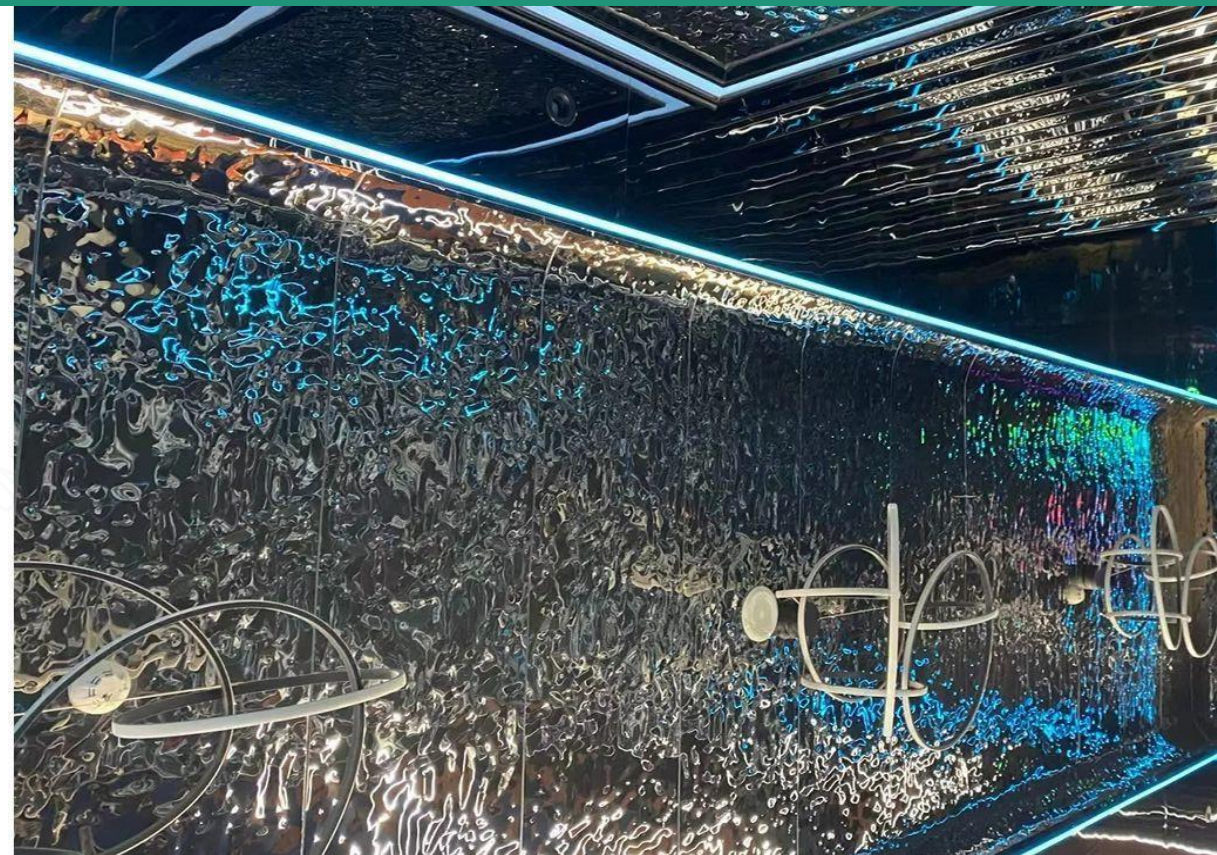

餐厅装饰/Restaurant decoration

镜面表面/MIRROR SURFACE

Stretch space, more elegant and
beautiful



竹木竹炭墙板

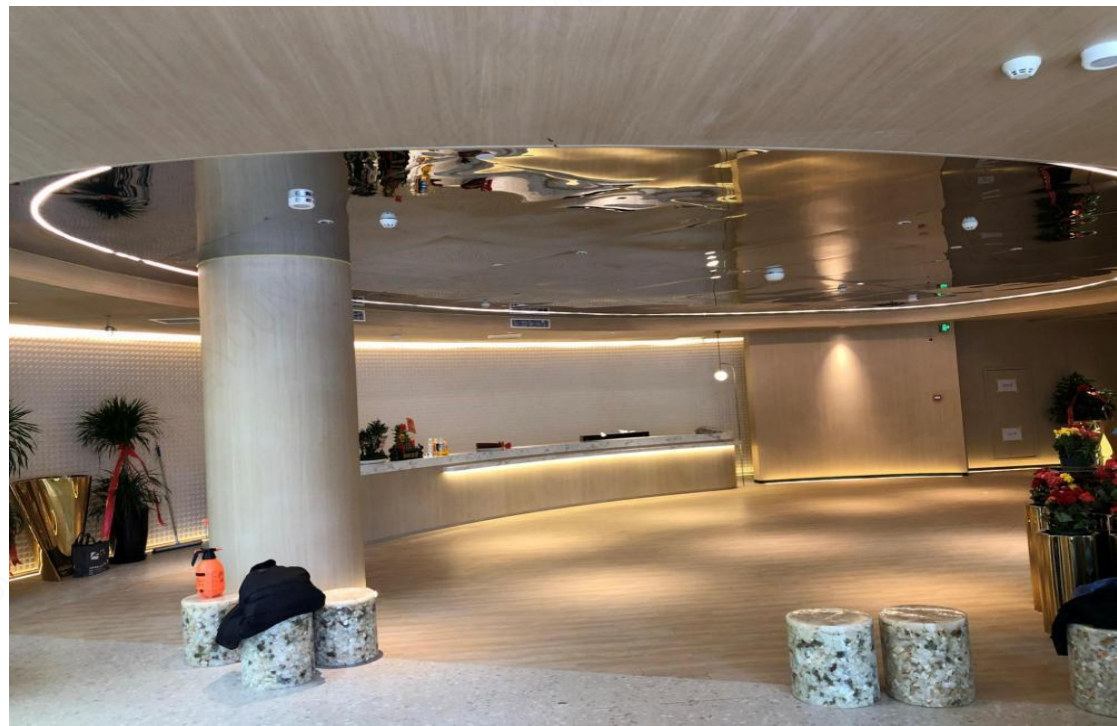
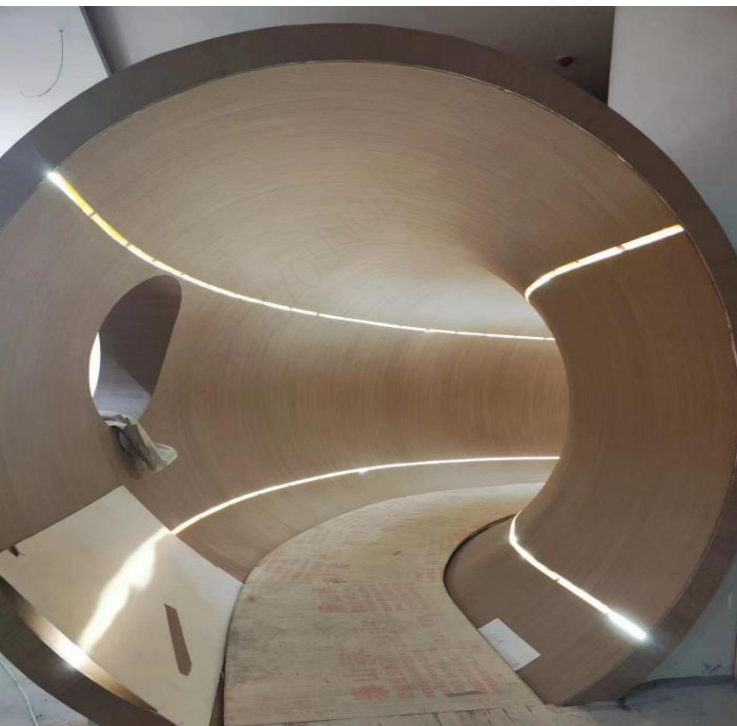
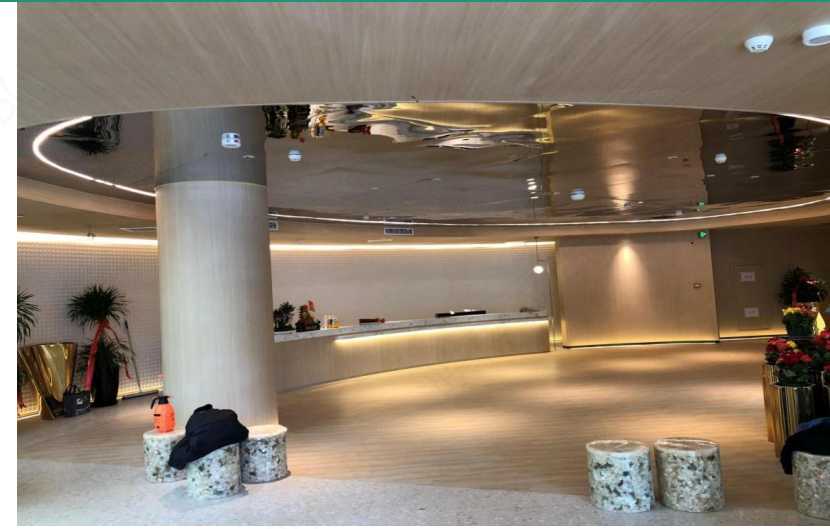
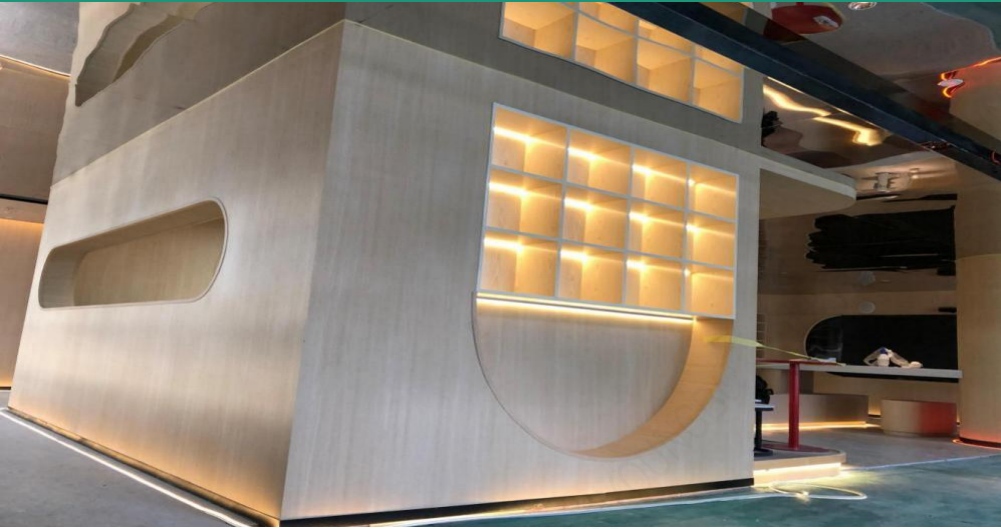

竹木竹炭墙板

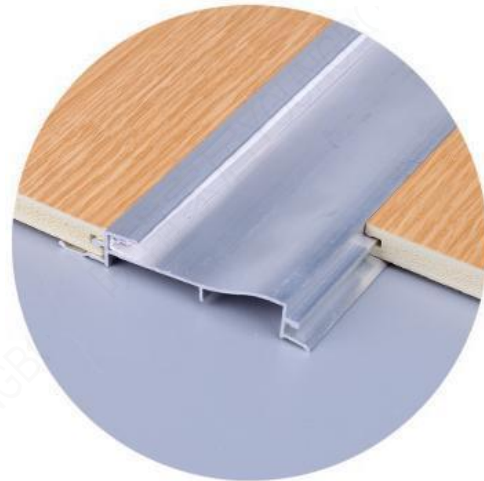

竹木竹炭墙板

Calcium silicate panel 硅酸钙板

01

耐磨保护层

02

装饰层

03

硅钙基材板



Specification 尺寸规格

厚度：5mm;6mm;8mm

Thickness: 5mm;6mm;8mm

宽度：1220mm

Width: 1220mm

长度：2440mm;3000mm;3200mm;定制

Length: 2440mm;3000mm;3200mm;定制

表面：见膜皮表（可定制）

Surface: Customized (film catalogue)

特点：防水防火，防虫，易清理，易于安装，现代化设计，环保

Features: Water Proof, Fire Proof, Anti Insect, Easy Clean,

Easy Installation, Modern Fashion Design, Environmental .

FEATURES 特性



A级防火/Class A fireproof



抗压耐磨/Compression & wear resistance



洁净抗菌/Clean antibacterial

竹木竹炭墙板

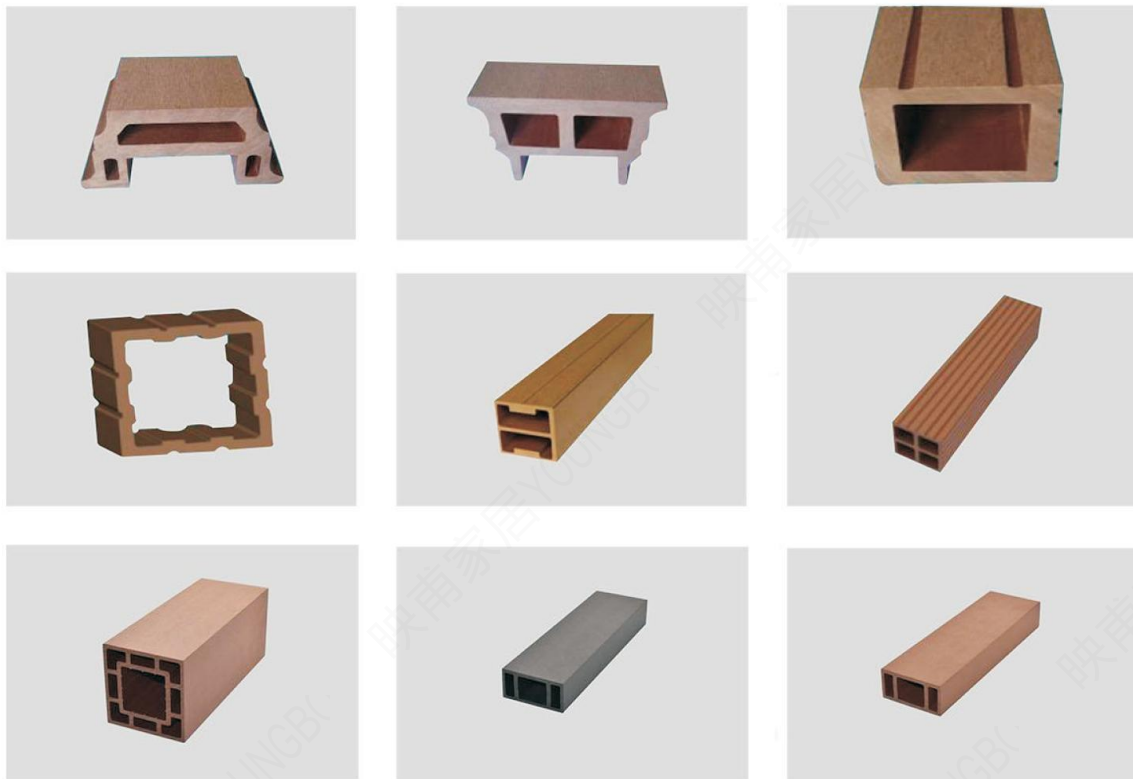

Product Description 产品规格

尺寸: 各种尺寸;定制

Size: varies size ;customized

表面: 见花色表 (可定制)

Surface: Customized (color catalogue)

材质: WPC+PVC/WOOD

Material: WPC+PVC/WOOD

特点: 防水防火, 防虫, 易清理, 易于安装, 现代化设计, 环保

Features: Water Proof, Fire Proof, Anti Insect, Easy Clean, Easy Installation, Modern Fashion Design, Environmental .



踢脚线及其它配件

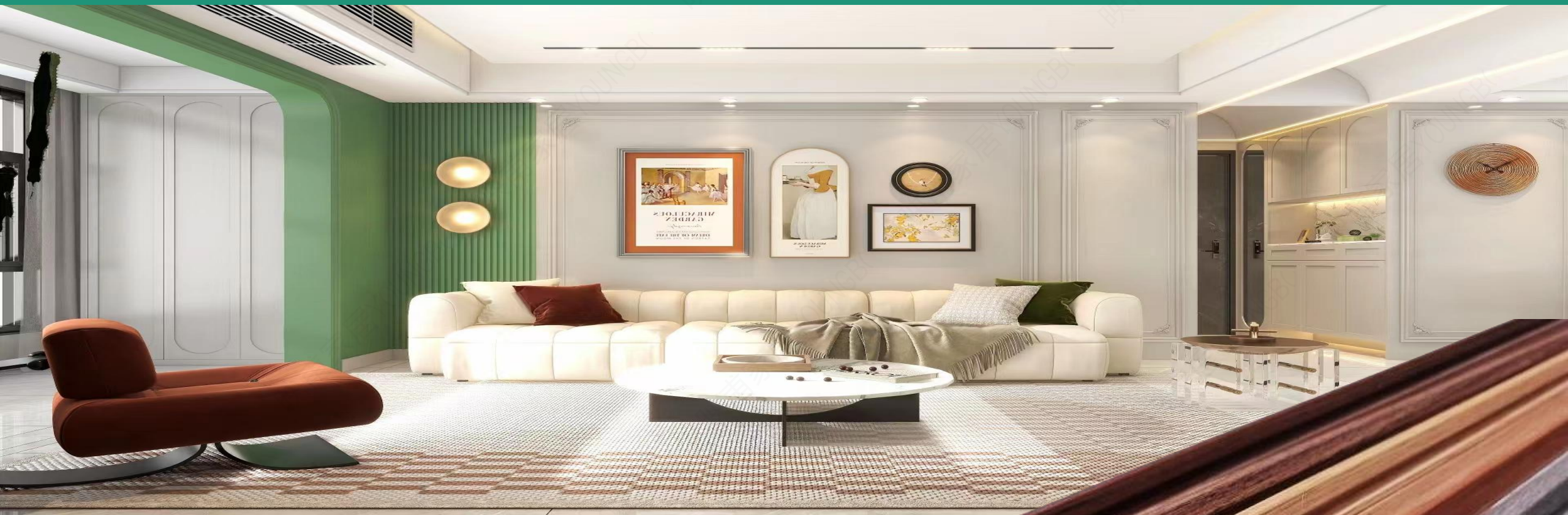

WPC SKIRTING BOARD 木塑踢脚线

木塑踢脚线使用全新环保WPC材质,不含甲醇及有害气体,是真正的绿色环保材料。可以达到欧洲的出口标准。其特点硬度高,不易变形,并且防水防火,防虫蛀,易于安装,且多种表面装饰,时尚个性,可充分与整体装修效果匹配。同时我们可以根据客户要求客户开新模/设计,根据客户的要求生产产品。



NO. : DC-01

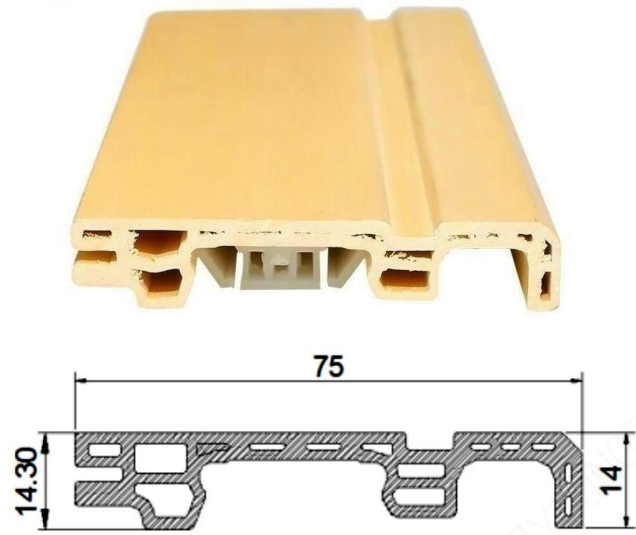

NO. : DC-03

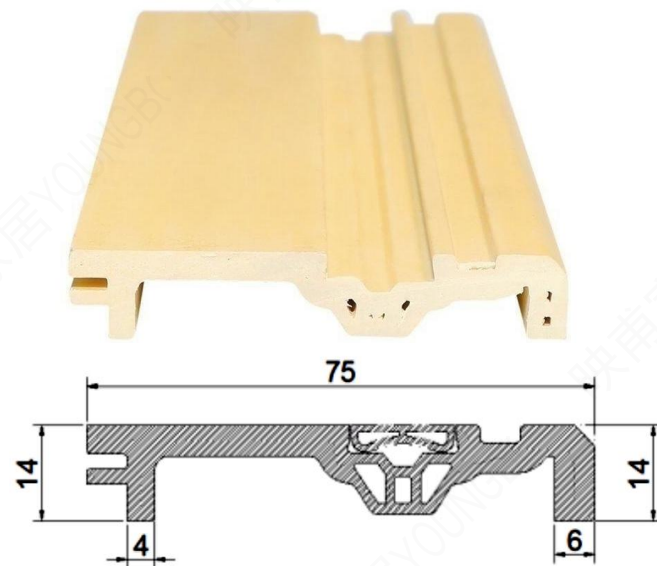

NO. : DC-05

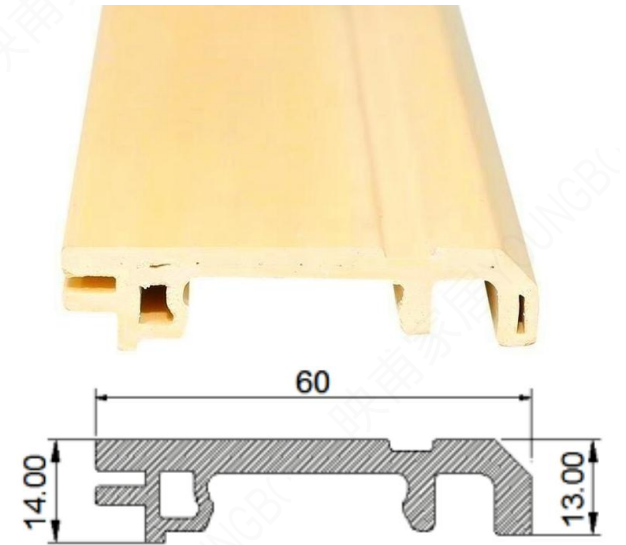

NO. : DC-02

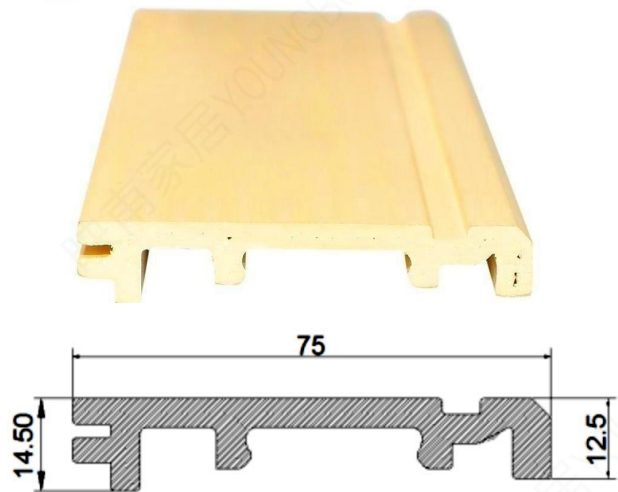

NO. : DC-04

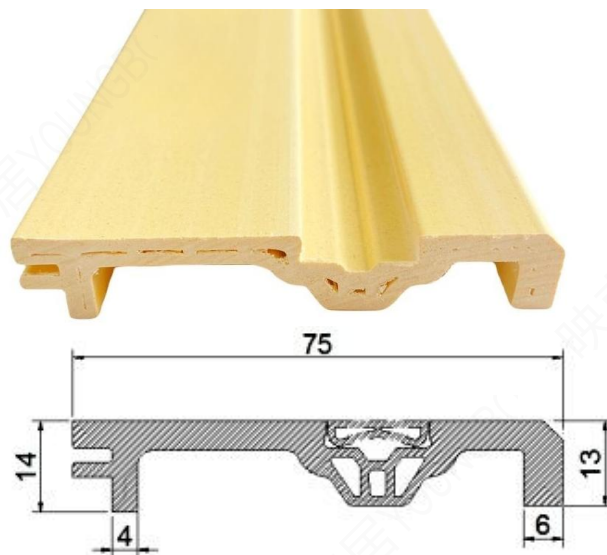

NO. : DC-06

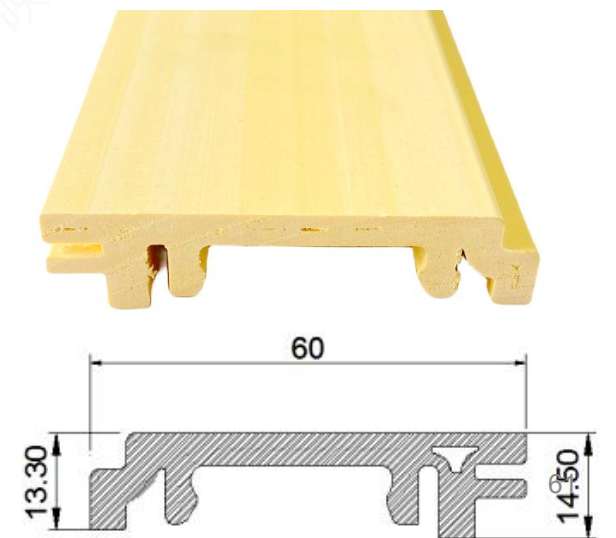

NO. : DC-07

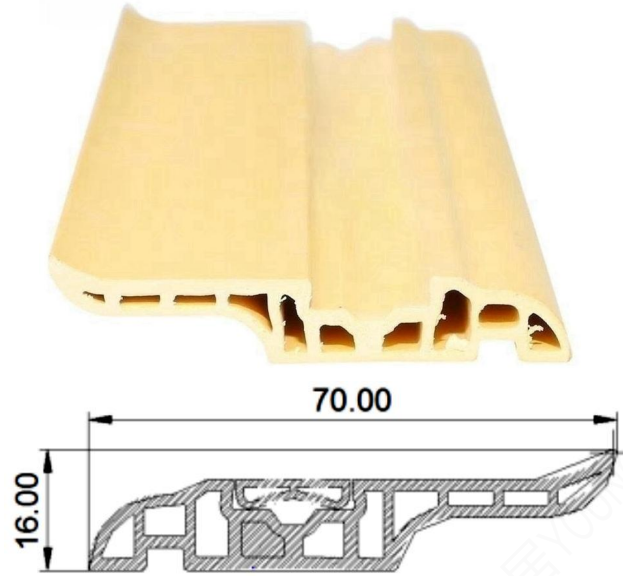

NO. : DC-0312G

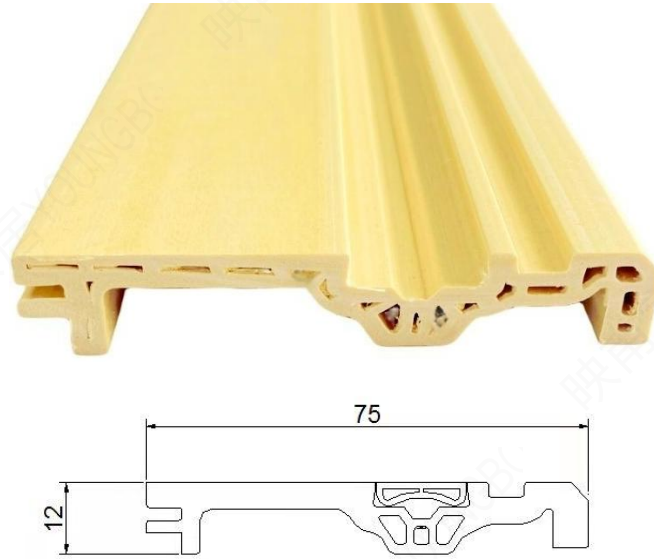

NO. : DC-4014P

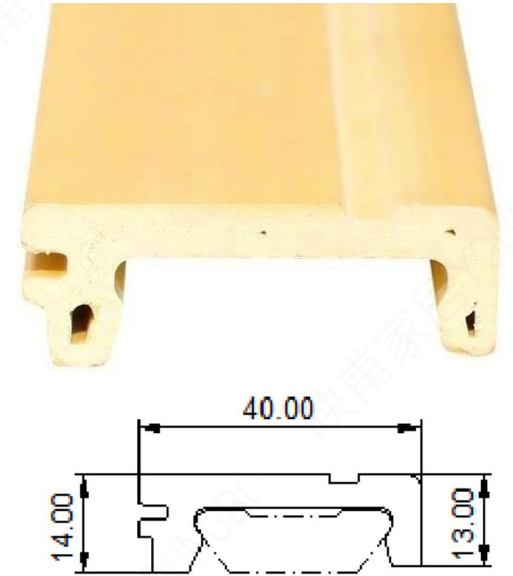

NO. : DC-0212

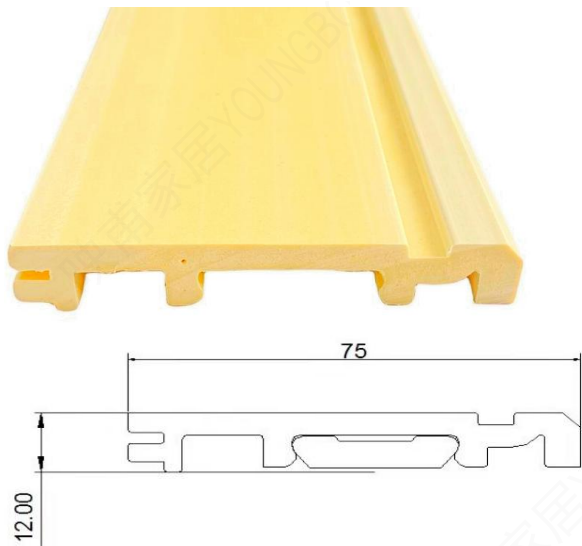

NO. : DC-4012

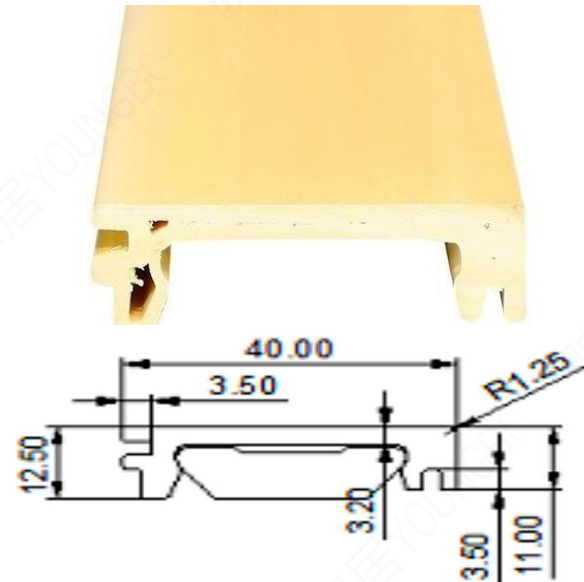

NO. : DC-0414Z

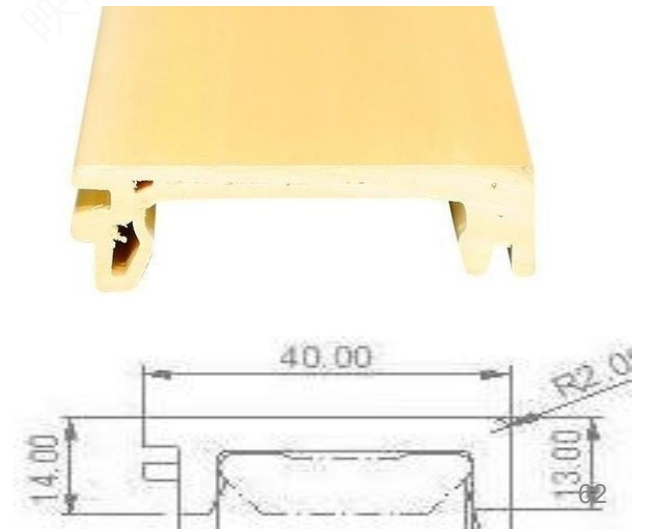

NO. : DC-5012P

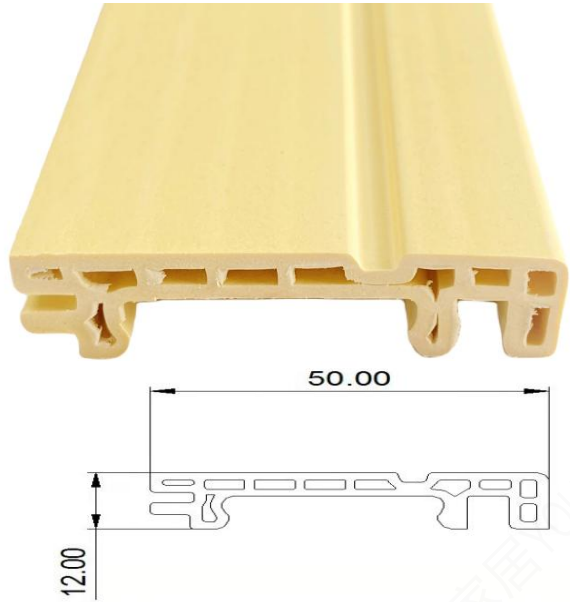

NO. : DC-6012G

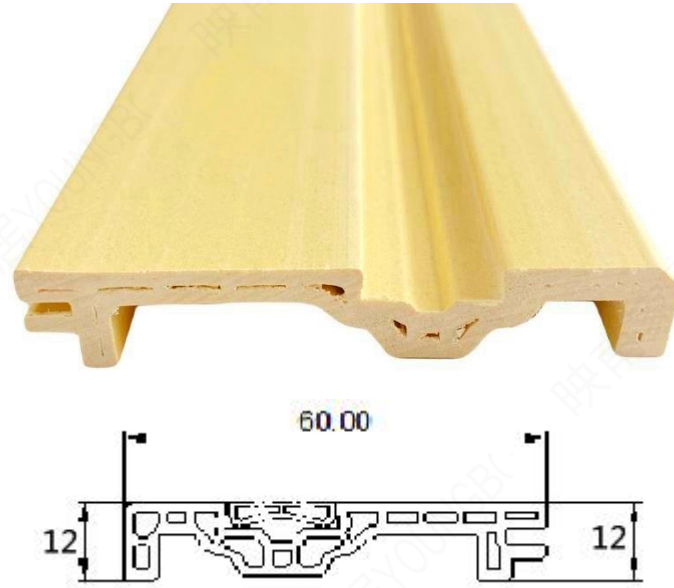

NO. : DC-6014

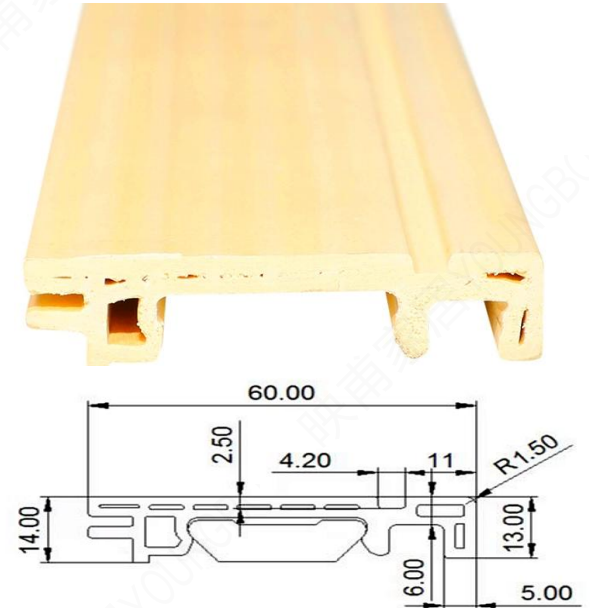

NO. : DC-5014

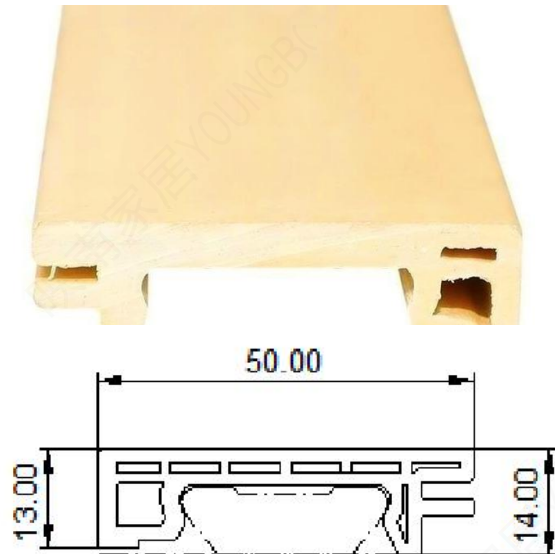

NO. : DC-6013

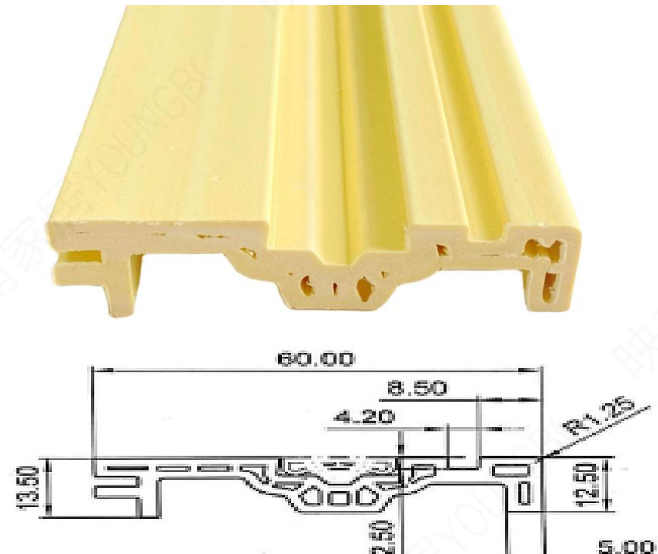

NO. : DC-0512

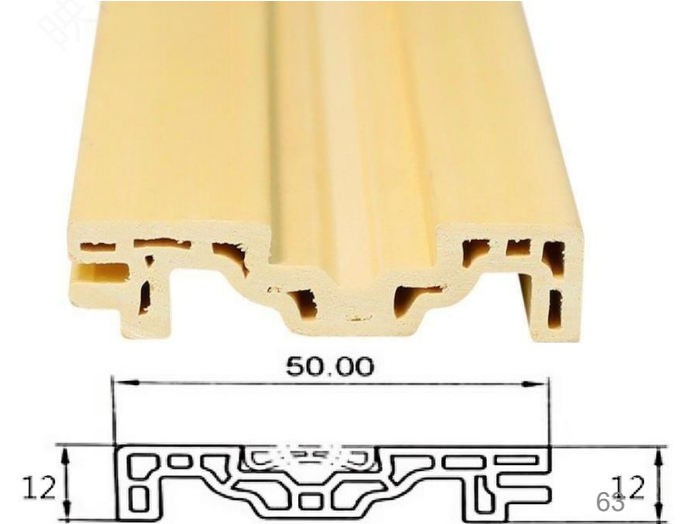

NO. : DC-7014

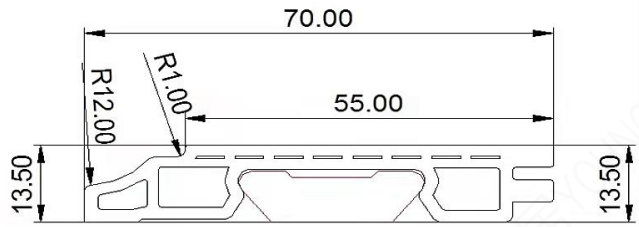

NO. : DC-10014-2

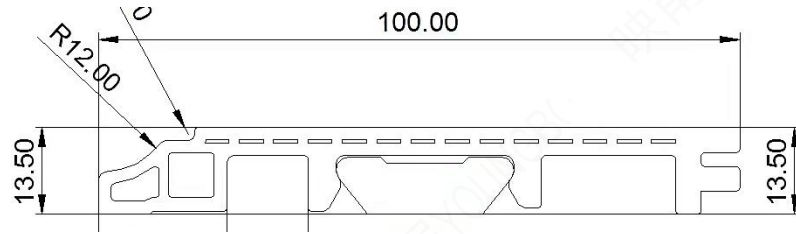

NO. : STX-14

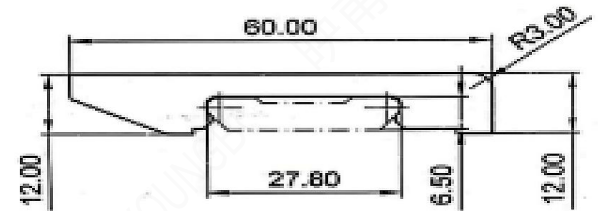

NO. : DC-10014

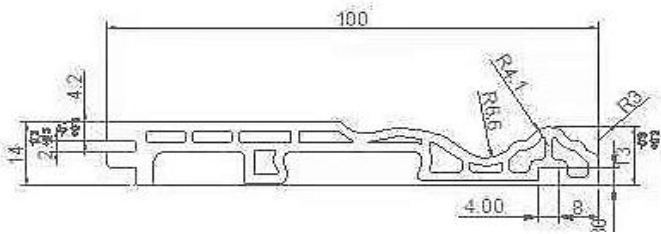

NO. : DC-15016

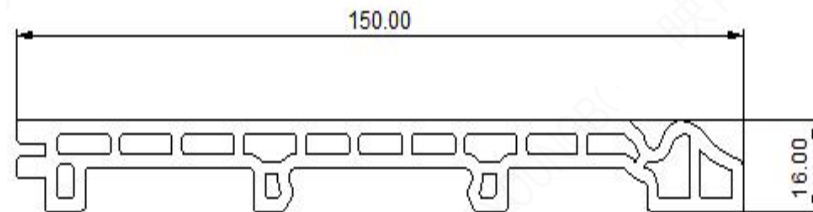
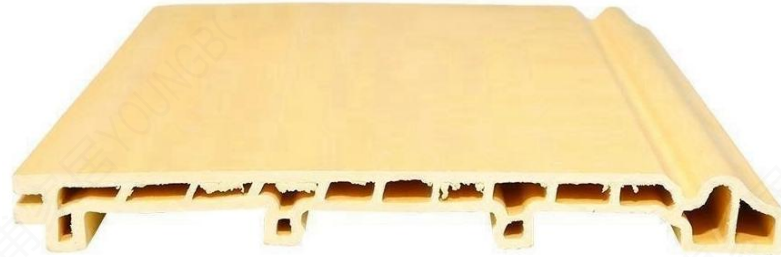

NO. : DC-6015G

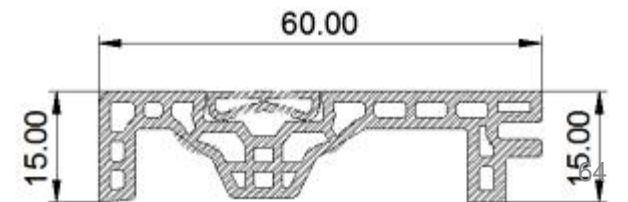

NO. : STX-15

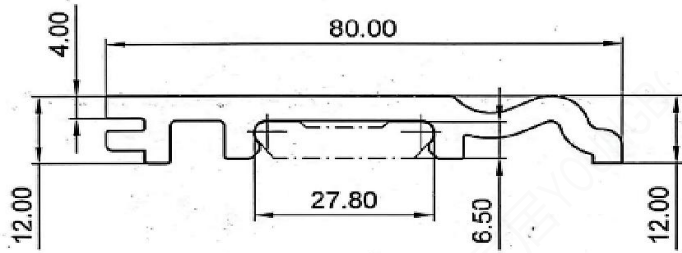

NO. : YG-L7515

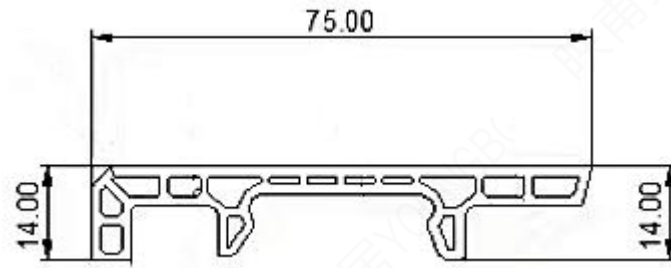

NO. : YG-M7812

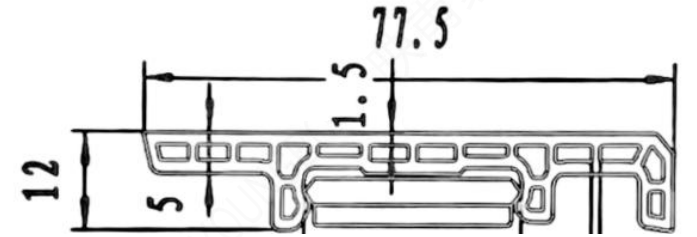
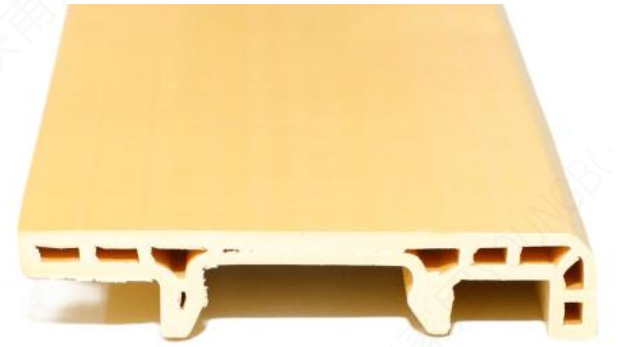

NO. : YG-L6014

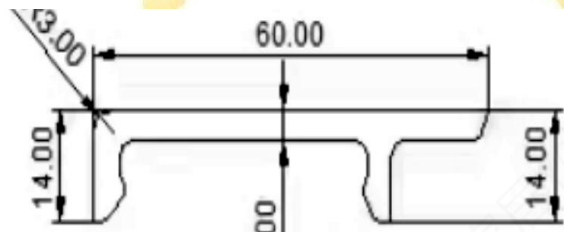

NO. : YG-M5014

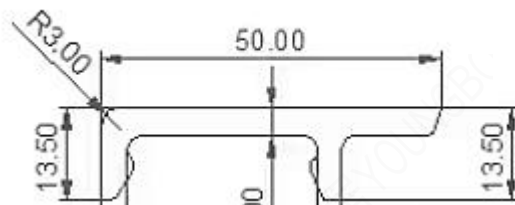
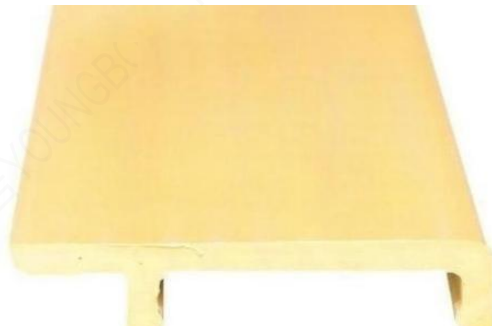

NO. : TG-T4B

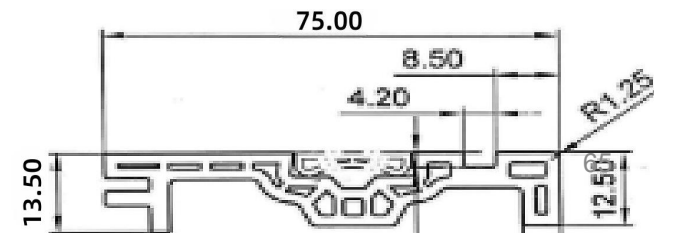

踢脚线及其它配件

 YG001	 YG002	 YG003	 YG004	 YG065	 YG066	 YG067	 YG069
 YG005	 YG006	 YG007	 YG008	 YG070	 YG073	 YG074	 YG079
 YG009	 YG010	 YG011	 YG012	 YG080	 YG081	 YG082	 YG083
 YG013	 YG014	 YG015	 YG016	 YG084	 YG085	 YG086	 YG087
 YG017	 YG018	 YG019	 YG020	 YG088	 YG089	 YG092	 YG093
 YG021	 YG025	 YG028	 YG043	 YG095	 YG096	 YG098	 YG101
 YG046	 YG050	 YG051	 YG053	 YG102	 YG103	 YG104	 YG105
 YG054	 YG056	 YG060	 YG062	 YG106	 YG107	 YG108	 YG109

踢脚线及其它配件



WOOD PROFILE, MDF, HDF/ 实木线条, 多层实木, 密度板

可生产各种尺寸外形实木线条, 可根据客户及设计要求定制不同造形, 免费开模, 免费样品
Can produce solid wood profiles of various sizes and shapes, can be customized according to customer and design requirements, free mold opening, free samples

踢脚线及其它配件

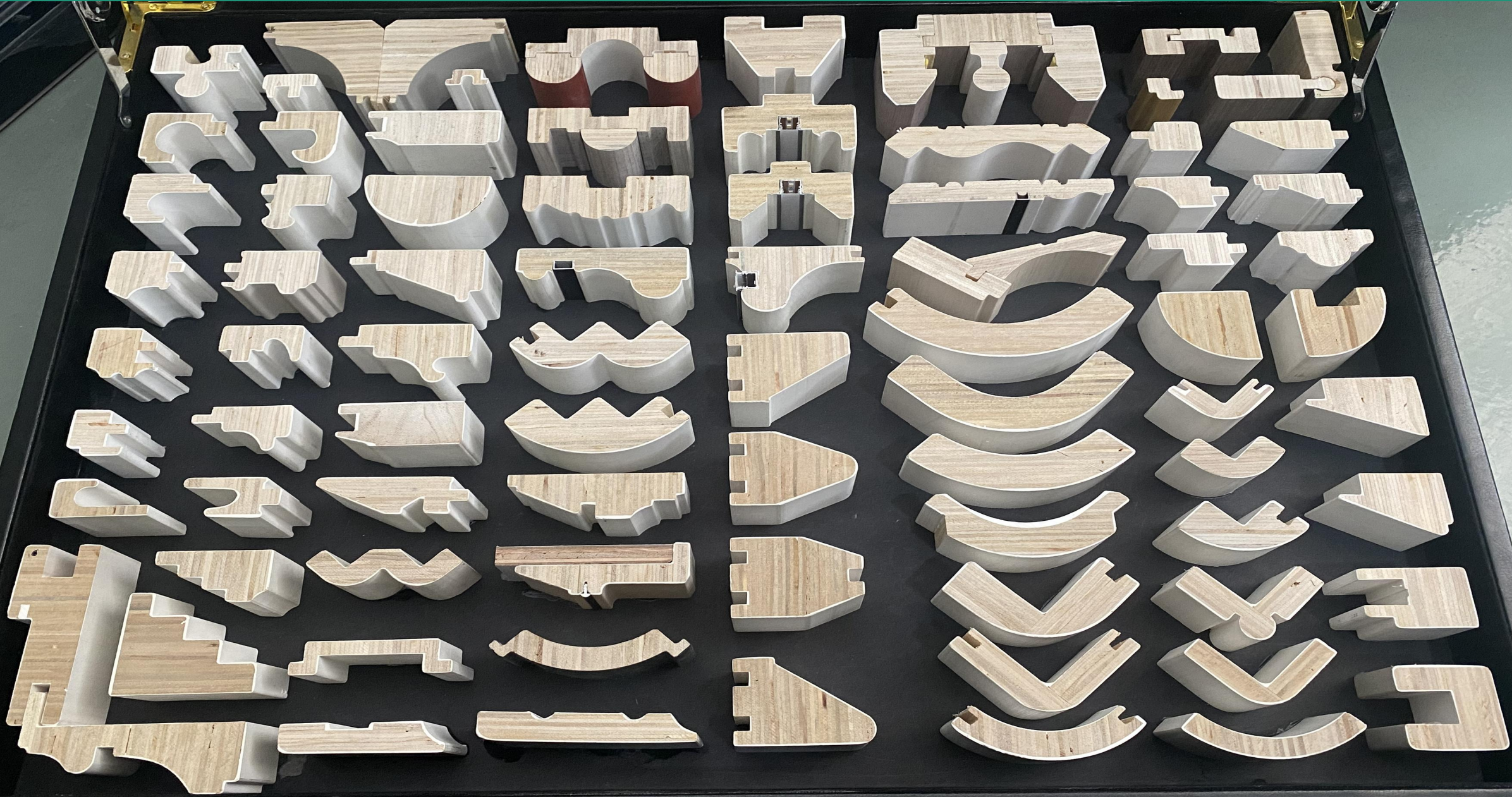

踢脚线及其它配件



踢脚线及其它配件



踢脚线及其它配件

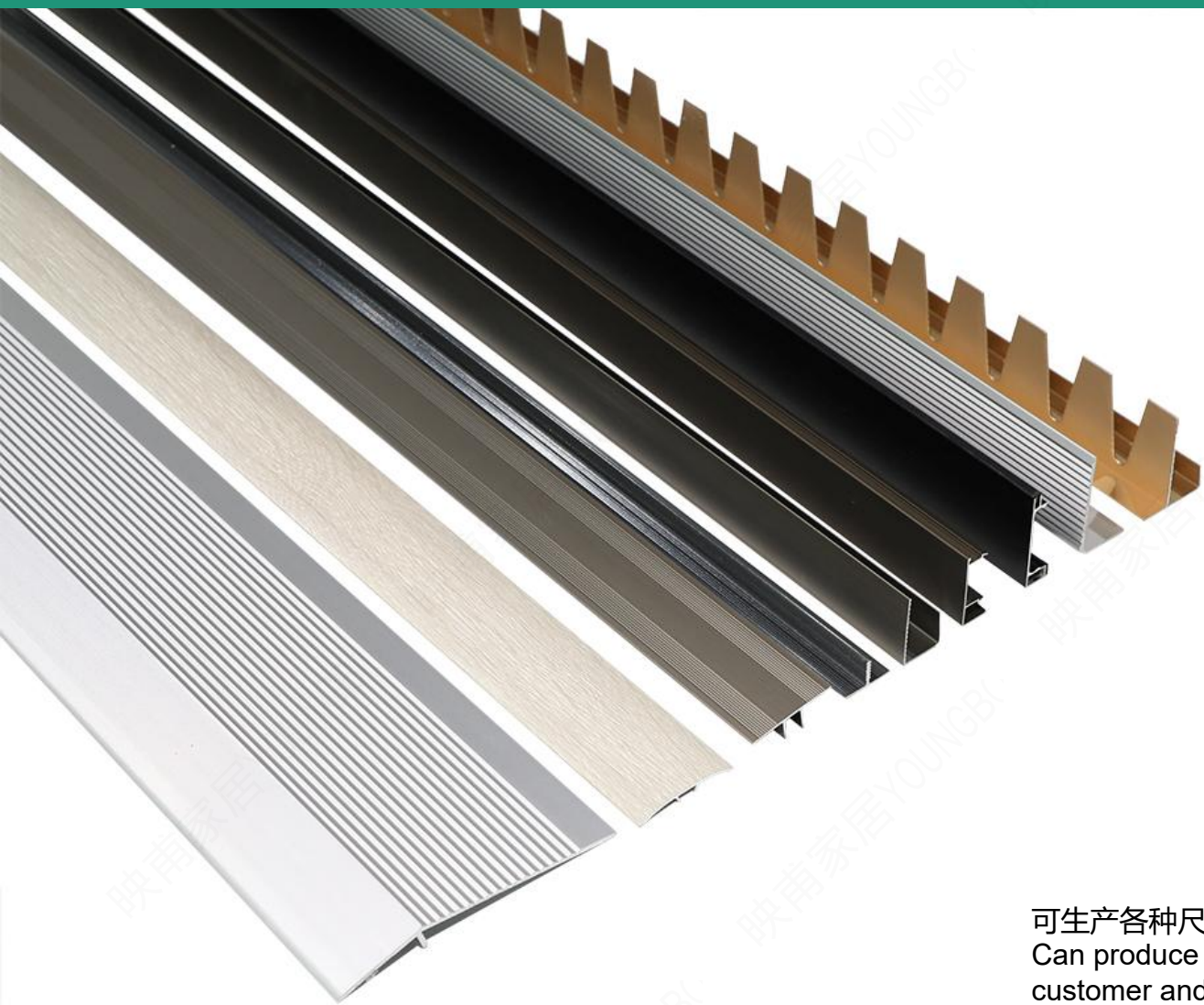

ALUMINUM PROFILE 铝合金型材

可生产各种尺寸外形铝合金型材，可根据客户及设计要求定制不同造形，免费开模，免费样品
Can produce aluminum of various sizes and shapes, can be customized according to customer and design requirements, free mold opening, free samples

踢脚线及其它配件

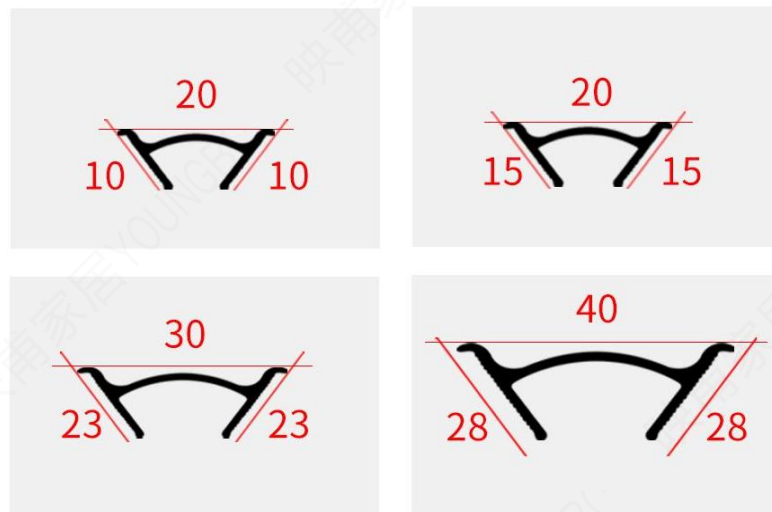
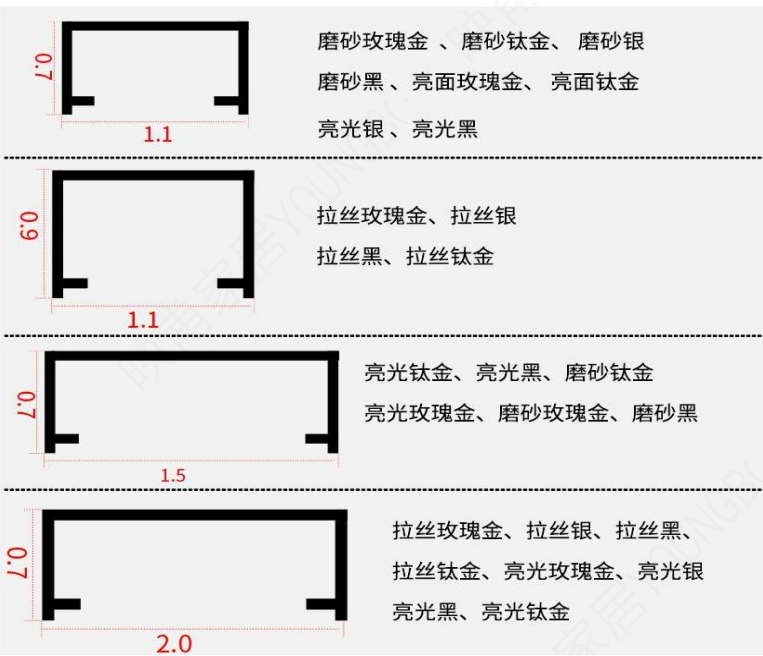
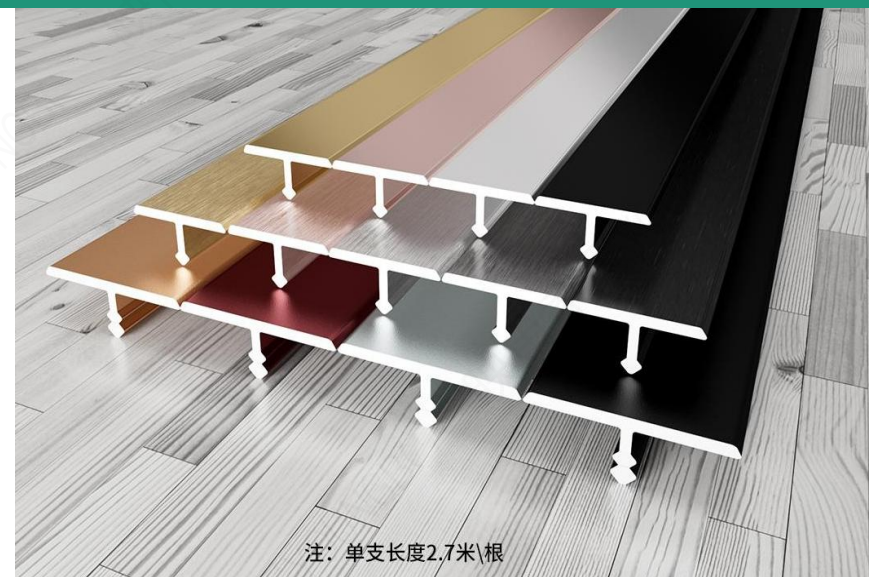
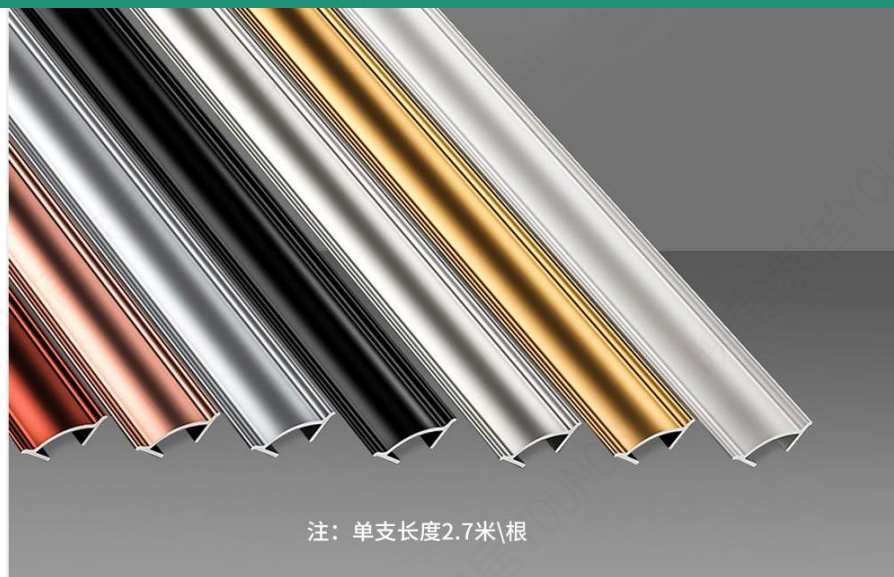
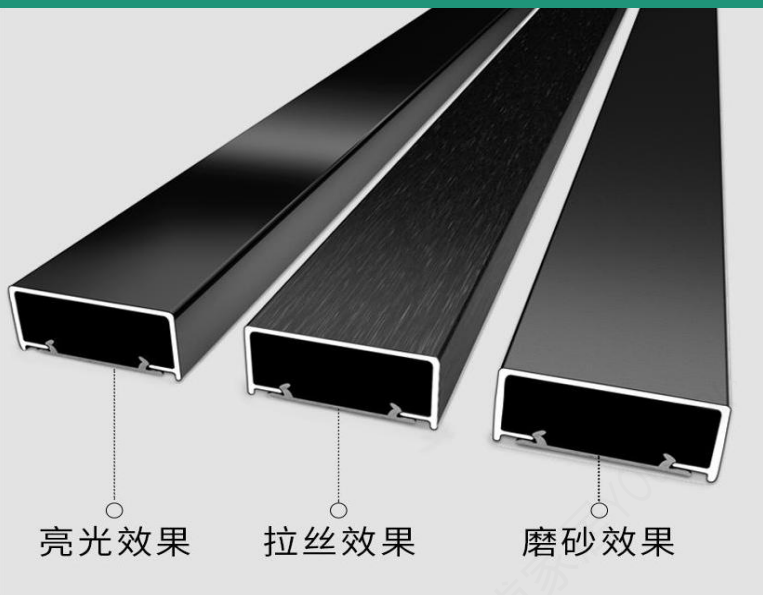

颜色 ▶ 黑色 铁灰色 玫瑰金 亮银色
紫金色 钛金色 瓷白色

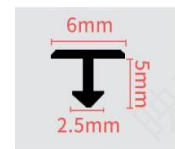

颜色：亮光黑色 亮光玫瑰金 亮光钛金 铁灰色拉丝 钛金拉丝
玫瑰金拉丝 银色拉丝 黑色拉丝 铁灰色磨砂 钛金磨砂
玫瑰金磨砂 银色磨砂 黑色磨砂

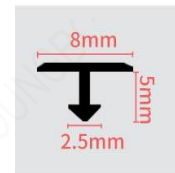

颜色：亮光玫瑰金 铁灰色拉丝 亮光黑色 黑色拉丝 亮光钛金
玫瑰金磨砂 亮光银色 银色磨砂 钛金拉丝 黑色磨砂
玫瑰金拉丝 铁灰色磨砂 银色拉丝 钛金磨砂

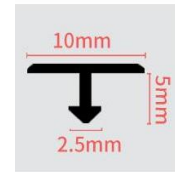

颜色：亮光玫瑰金 铁灰色拉丝 亮光黑色 黑色拉丝 亮光钛金
玫瑰金磨砂 亮光银色 银色磨砂 钛金拉丝 黑色磨砂
玫瑰金拉丝 铁灰色磨砂 银色拉丝 钛金磨砂

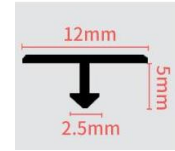

颜色：亮光银色 黑色拉丝 亮光玫瑰金 铁灰色磨砂 铁灰色拉丝
钛金磨砂 钛金拉丝 玫瑰金磨砂 玫瑰金拉丝 银色磨砂
银色拉丝 黑色磨砂

踢脚线及其它配件

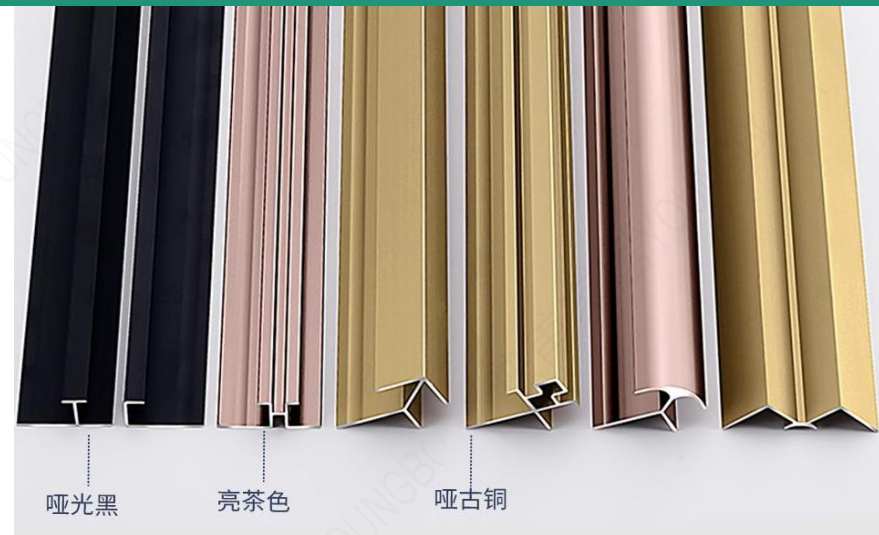
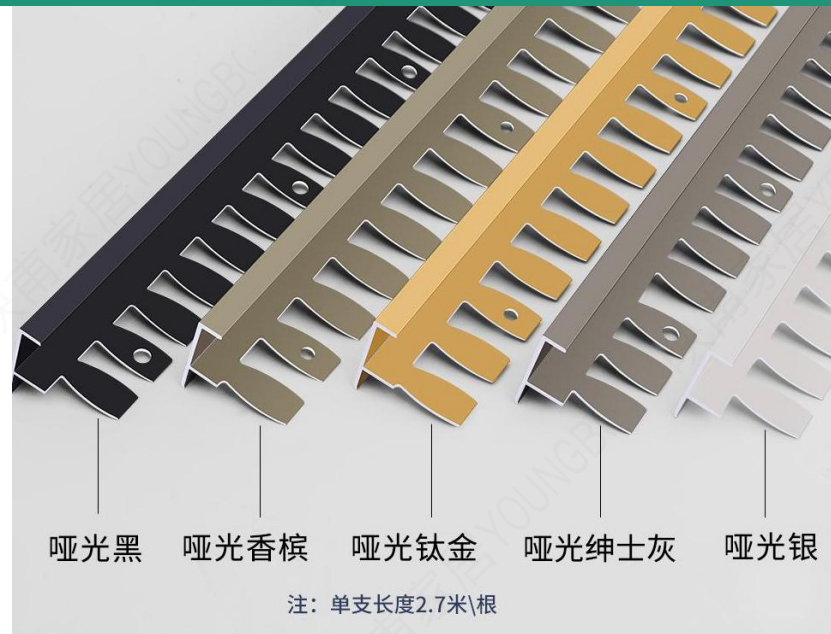
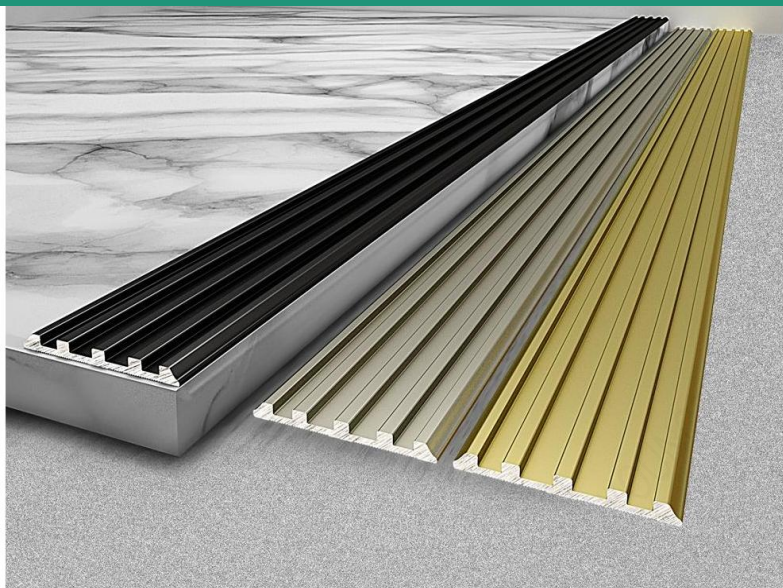

宽：4cm



厚：2.6mm

宽：49.0mm



厚：2.6mm

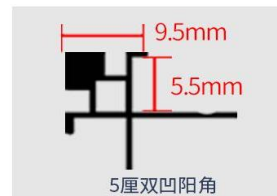
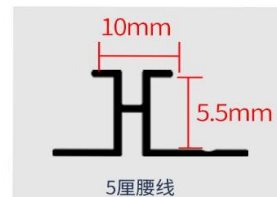
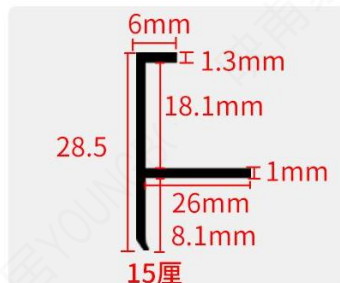
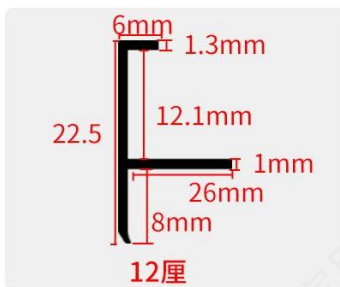

踢脚线及其它配件

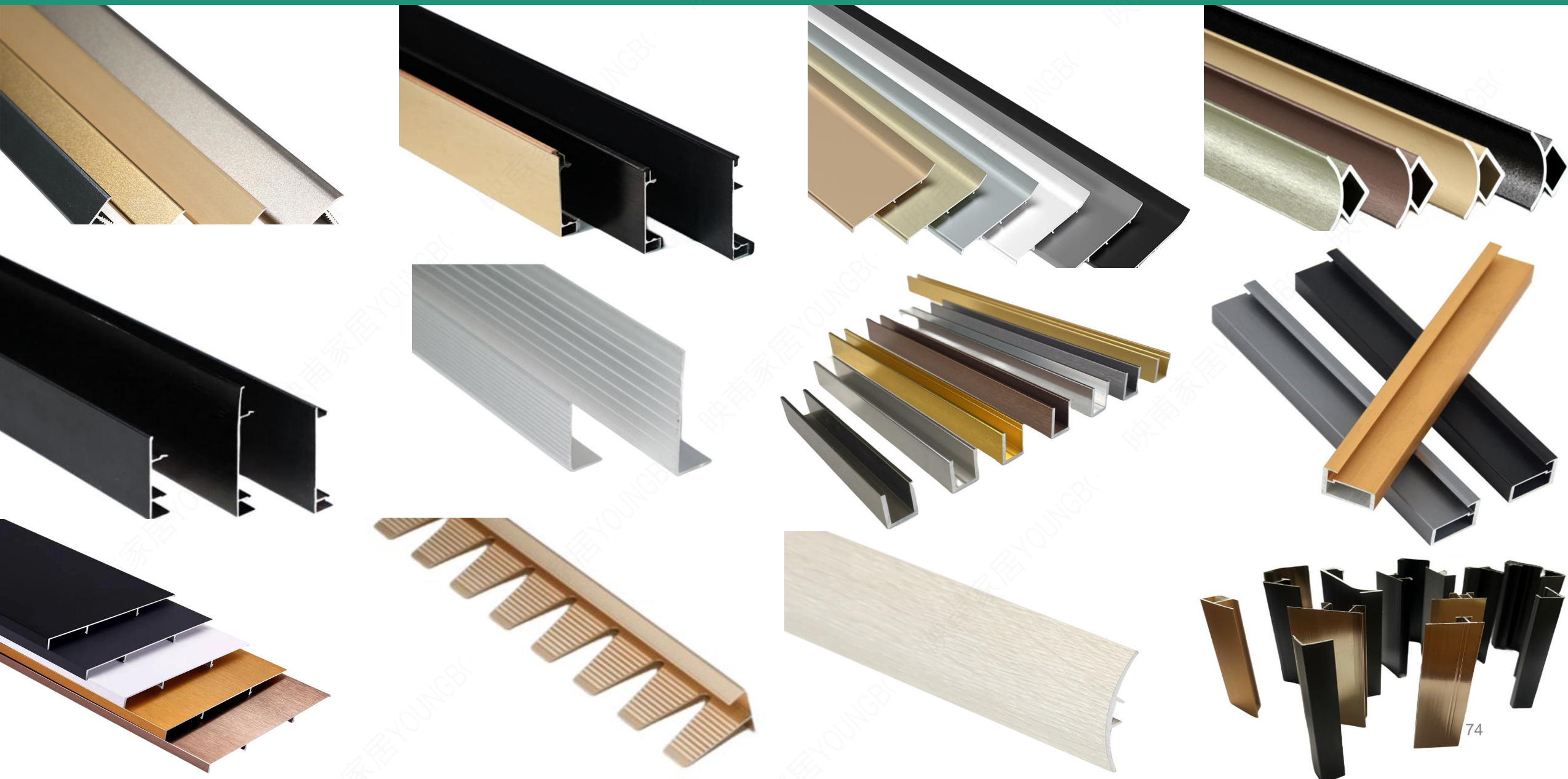

THE END

青岛星航维度国际贸易有限公司
Qingdao Stellarverse International Co.,Ltd